

M980xA Series PXIe Vector Network Analyzer

9 kHz to 4.5/6.5/9/14/20 GHz, 2/4/6-port

100 kHz to 26.5/32/44/53 GHz, 2-port

Introduction

As the margins for multiport devices become tighter, your test equipment needs to be one step ahead. The Keysight M980xA PXIe Vector Network Analyzer (VNA) meets the most demanding multiport challenges with a true multiport architecture that offers exceptional performance no matter how many ports you use. Gain deeper insights into your devices with the widest available portfolio of measurement applications for PXI VNAs, including spectrum analysis, pulsed-RF measurements, and more.

The M980xA Series offers the performance required for testing passive components, amplifiers, mixers, or frequency converters. It provides key PXI VNA specifications such as dynamic range, measurement speed, trace noise and temperature stability. Each module is a completely independent vector network analyzer with 2-, 4- or 6-ports up to 20 GHz, or 2-ports up to 53 GHz. The modules are easily configured as a true multiport VNA by using additional modules installed in the same chassis, and a VNA with up to 50-ports can be configured in a single chassis for multiport applications. All test ports are fully synchronous, so multiple ports can be measured simultaneously with multiport error correction applied.



Table of Contents

Definition	3
Dynamic Range.....	4
Corrected System Performance.....	5
Uncorrected System Performance	10
Test Port Output.....	12
Test Port Input.....	16
Dynamic Accuracy	20
Spectrum Analysis (with Option 090/190 and S95090B).....	21
Pulsed-RF Measurements (with Option 021 and S95024B/S95025B).....	30
Enhanced Time Domain Analysis with TDR (S95011B).....	36
Multi-module Measurements with S95551B Software	38
General Information	42
Measurement Throughput.....	47
Test Set Block Diagrams.....	50
Literature Information	51
Web Resources.....	51
Confidently Covered by Keysight Services	52

Definition

Specification (spec)¹

Warranted performance. Specifications include guardbands to account for the expected statistical performance distribution, measurement uncertainties, and changes in performance due to environmental conditions. All specifications and characteristics apply over a $25\text{ °C} \pm 5\text{ °C}$ (unless otherwise stated).

The following conditions must be met:

- Module temperature is between 37 to 50 °C (2-port option), 40 to 53 °C (4-port option) and 43 to 56 °C (6-port option).
- Instrument has been turned on for 60 minutes with VNA application running.
- Instrument is within its calibration cycle.
- Instrument remains at a stable surrounding environment temperature (between -10 °C to 55 °C) for 60 minutes prior to turn-on.

Characteristics (char.)

A performance parameter that the product is expected to meet before it leaves the factory, but that is not verified in the field and is not covered by the product warranty. A characteristic includes the same guardbands as a specification.

Typical (typ.)

Expected performance of an average unit at a stable temperature between $25\text{ °C} \pm 5\text{ °C}$ for 60 minutes prior to turn-on and during operation; does not include guardbands. It is not covered by the product warranty. The instrument must be within its calibration cycle.

Nominal (nom.)

A general, descriptive term or design parameter. It is not tested, and not covered by the product warranty.

Supplemental Information

A performance parameter that is tested on sampled product during design validation. It does not include guardbands and is not covered by the product warranty.

Calibration

The process of measuring known standards to characterize an instrument's systematic (repeatable) errors.

Corrected (residual)

Indicates performance after error correction (calibration). It is determined by the quality of calibration standards and how well "known" they are, plus system repeatability, stability, and noise.

Uncorrected (raw)

Indicates instrument performance without error correction. The uncorrected performance affects the stability of a calibration.

1. For all tables in this data sheet, the specified performance at the exact frequency of a break is the better value of the two specifications at that frequency.

Dynamic Range

The specifications in this section apply to measurements made with the Keysight M980xA vector network analyzer under the following conditions:

- 10 Hz IF bandwidth
- No averaging applied to data

Table 1. System dynamic range at test port (dB)¹

M9800A, M9801A, M9802A, M9803A, M9804A

Description	Specification	Typical
9 kHz to 100 kHz	101	111
100 kHz to 300 kHz	117	126
300 kHz to 1 MHz	125	136
1 MHz to 10 MHz	130	141
10 MHz to 50 MHz ²	137	147
50 MHz to 3 GHz	140	150
3 GHz to 5 GHz	140	149
5 GHz to 6.5 GHz	140	148
6.5 GHz to 9 GHz	136	146
9 GHz to 14 GHz	133	142
14 GHz to 16 GHz	130	140
16 GHz to 20 GHz	126	137

M9805A, M9806A, M9807A, M9808A

Description	Specification	Typical
100 kHz to 300 kHz	95	106
300 kHz to 500 kHz	104	120
500 kHz to 1 MHz	117	130
1 MHz to 10 MHz	125	138
10 MHz to 50 MHz ²	137	147
50 MHz to 6.5 GHz	140	150
6.5 GHz to 8 GHz	138	150
8 GHz to 9 GHz	138	147
9 GHz to 16 GHz	137	147
16 GHz to 17 GHz	137	143
17 GHz to 20 GHz	132	143
20 GHz to 24 GHz	130	143
24 GHz to 25 GHz	130	141
25 GHz to 26 GHz	127	141
26 GHz to 30 GHz	127	137
30 GHz to 35 GHz	122	137

35 GHz to 40 GHz	122	134
40 GHz to 45 GHz	122	132
45 GHz to 50 GHz	100	115
50 GHz to 53 GHz	72	101

1. System dynamic range = source maximum output power minus receiver noise floor. Does not include crosstalk effects
2. It may typically be degraded at 25 MHz.

Corrected System Performance

This section provides specifications for the corrected performance of the M980xA PXIe VNA using either of the 85032F, 85052D, 85058B Mechanical Calibration Kit or the N4691D, N4694D Electronic Calibration (ECal) Module. To determine transmission and reflection uncertainty curves with other calibration kits, please download the Uncertainty Calculator from http://www.keysight.com/find/na_calculator to generate the curves for your specific calibration kit.

Measured with 10 Hz IF bandwidth, no averaging applied to data, environmental temperature = 23 °C (± 3 °C) with < 1 °C deviation from calibration temperature.

Table 2. M9800A, M9801A, M9802A, M9803A or M9804A with 85032F standard mechanical calibration kit

Corrected error terms (dB) – Specifications

Description	9 kHz to 50 MHz	50 MHz to 3 GHz	3 GHz to 6 GHz	6 GHz to 9 GHz
Directivity	49	46	40	38
Source match	41	40	36	35
Load match	47	46	40	38
Reflection tracking	± 0.011	± 0.021	± 0.032	± 0.054
Transmission tracking	± 0.082	± 0.021	± 0.063	± 0.074

Transmission uncertainty (magnitude and phase)

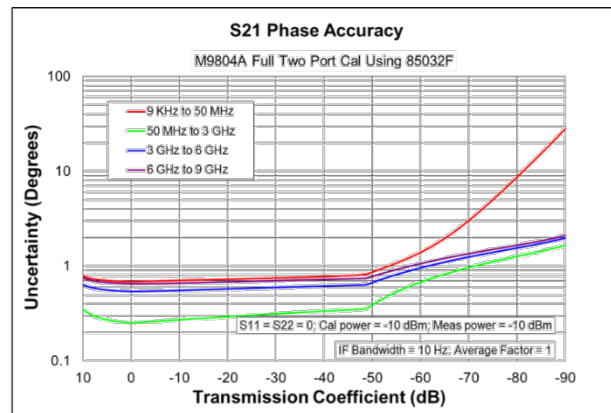
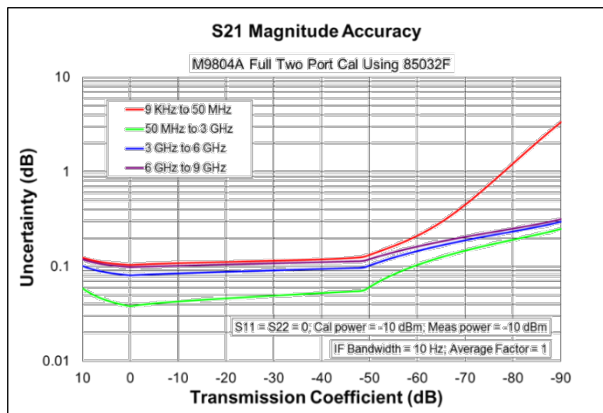

Reflection uncertainty (magnitude and phase)

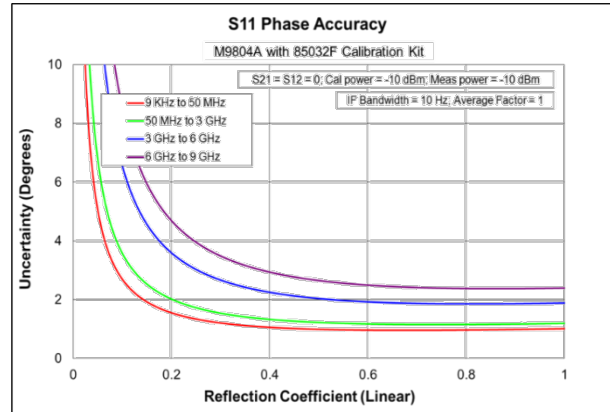
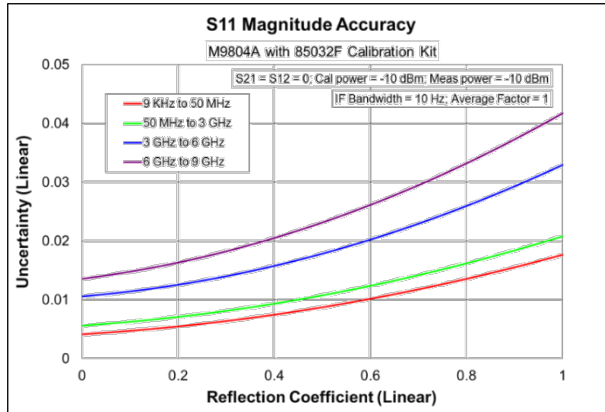
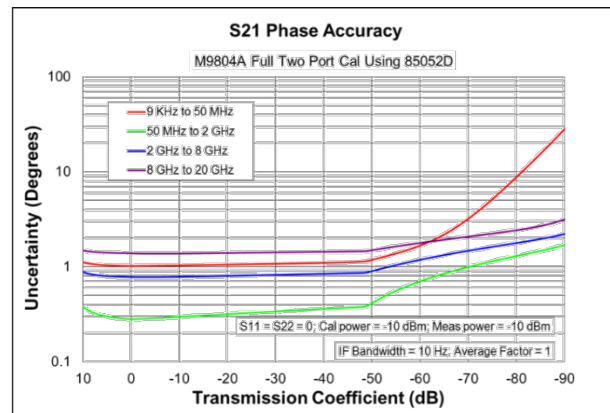
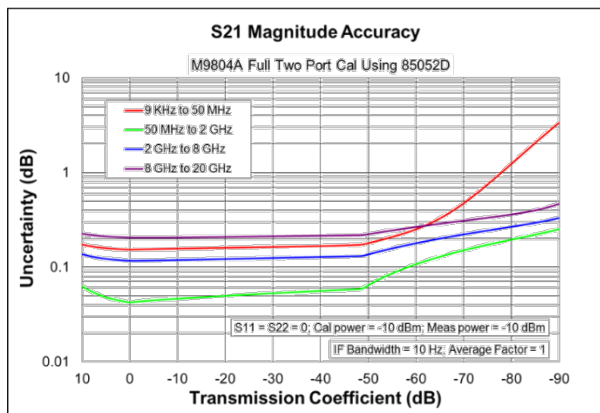

Table 3. M9800A, M9801A, M9802A, M9803A or M9804A with 85052D economy mechanical calibration kit

Corrected error terms (dB) – Specifications

Description	9 kHz to 50 MHz	50 MHz to 2 GHz	2 GHz to 8 GHz	8 GHz to 20 GHz
Directivity	42	42	38	36
Source match	37	37	31	28
Load match	42	42	38	36
Reflection tracking	± 0.003	± 0.003	± 0.004	± 0.008
Transmission tracking	± 0.136	± 0.03	± 0.1	± 0.185

Transmission uncertainty (magnitude and phase)



Reflection uncertainty (magnitude and phase)

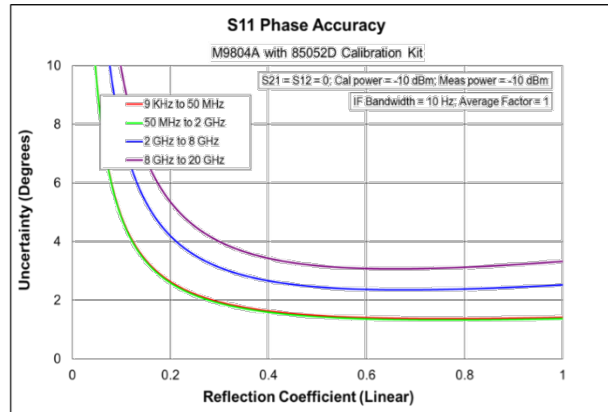
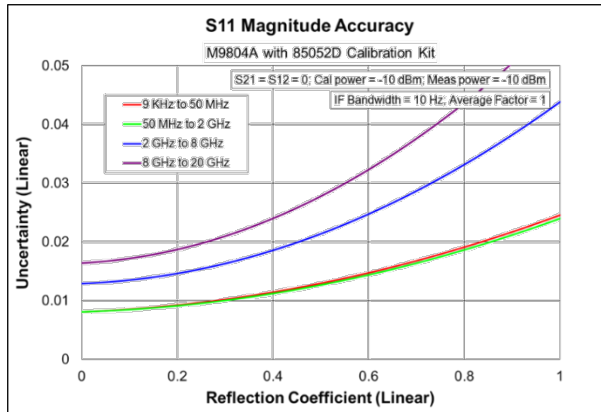
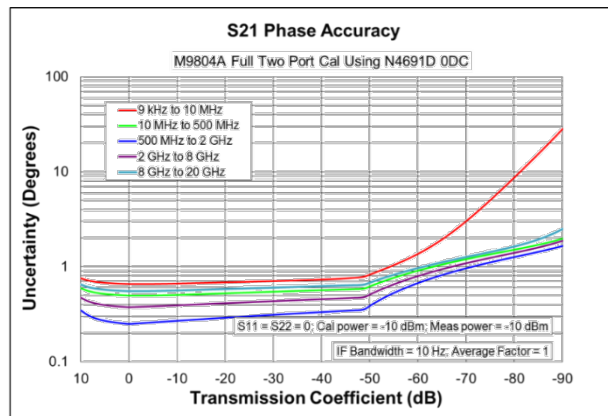
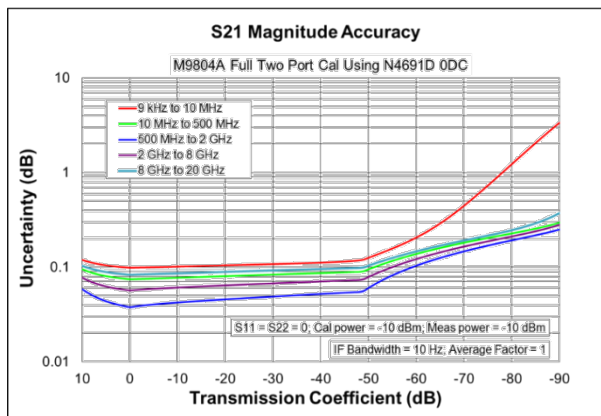

Table 4. M9800A, M9801A, M9802A, M9803A or M9804A with N4691D Electronic Calibration (ECal) module with Option 0DC

Corrected error terms (dB) – Specifications

Description	9 kHz to 10 MHz	10 MHz to 500 MHz	500 MHz to 2 GHz	2 GHz to 8 GHz	8 GHz to 20 GHz
Directivity	46	46	47	46	43
Source match	41	41	47	45	42
Load match	38	40	46	44	40
Reflection tracking	± 0.05	± 0.05	± 0.002	± 0.03	± 0.04
Transmission tracking	± 0.081	± 0.056	± 0.026	± 0.042	± 0.064

Transmission uncertainty (magnitude and phase)



Reflection uncertainty (magnitude and phase)

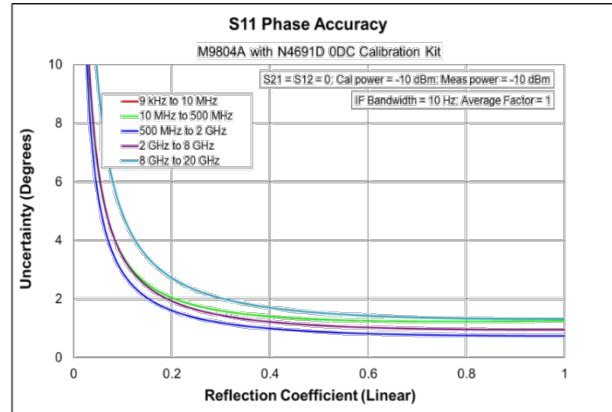
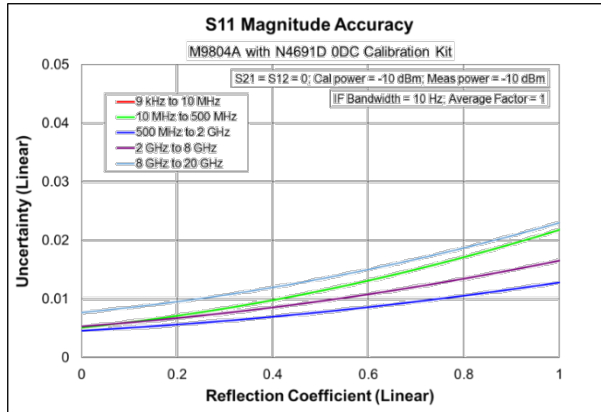
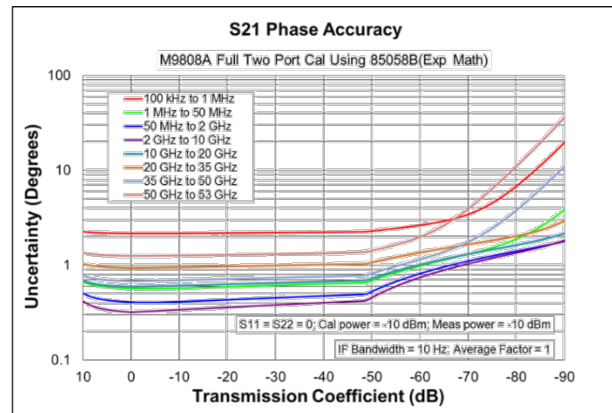
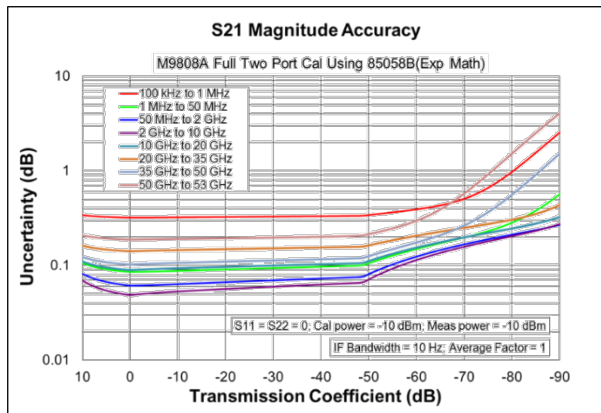

Table 5. M9805A, M9806A, M9807A or M9808A with 85058B standard mechanical calibration kit

Corrected error terms (dB) – Specifications

Description	100 kHz to 1 MHz	1 MHz to 50 MHz	50 MHz to 2 GHz	2 GHz to 10 GHz	10 GHz to 20 GHz	20 GHz to 35 GHz	35 GHz to 50 GHz	50 GHz to 53 GHz
Directivity	35	35	35	41	38	37	37	34
Source match	34	34	34	44	40	41	42	40
Load match	34	35	35	41	37	36	36	33
Reflection tracking	± 0.019	± 0.019	± 0.019	± 0.01	± 0.033	± 0.033	± 0.02	± 0.03
Transmission tracking	± 0.302	± 0.065	± 0.046	± 0.033	± 0.073	± 0.122	± 0.079	± 0.154

Transmission uncertainty (magnitude and phase)



Reflection uncertainty (magnitude and phase)

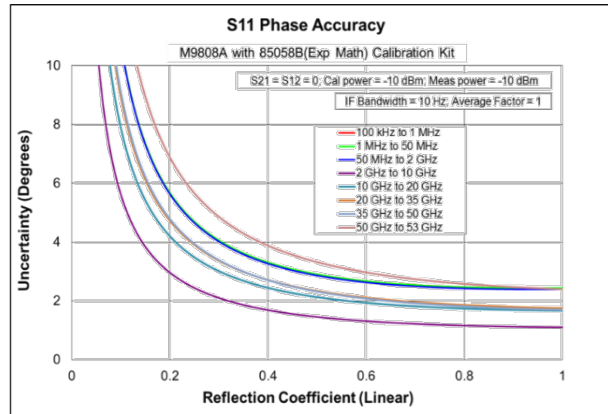
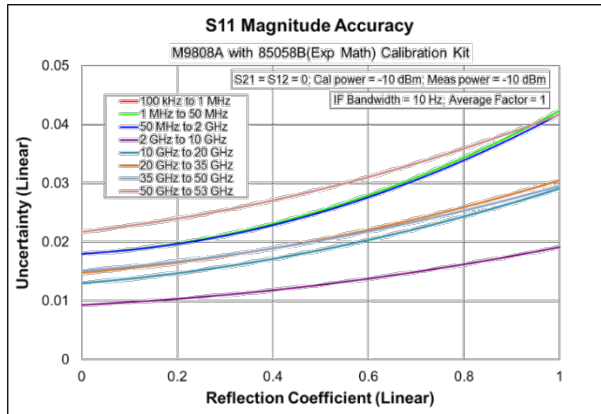
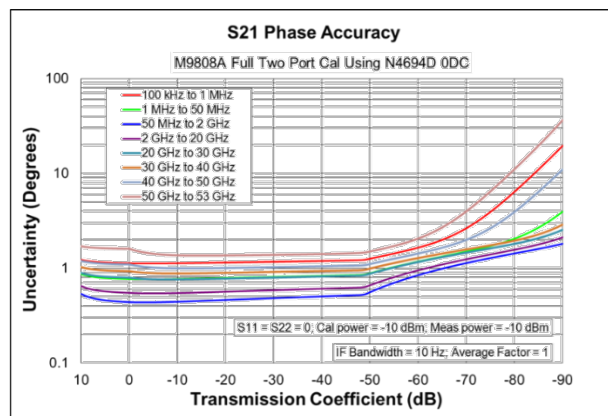
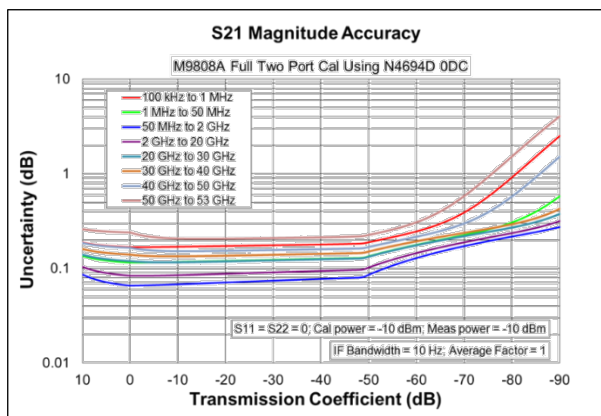

Table 6. M9805A, M9806A, M9807A or M9808A with N4694D Electronic Calibration (ECal) module with Option 0DC

Corrected error terms (dB) – Specifications

Description	100 kHz to 1 MHz	1 MHz to 50 MHz	50 MHz to 2 GHz	2 GHz to 20 GHz	20 GHz to 30 GHz	30 GHz to 40 GHz	40 GHz to 50 GHz	50 GHz to 53 GHz
Directivity	41	41	41	42	41	40	38	35
Source match	38	38	38	39	35	34	33	30
Load match	34	37	38	38	34	32	32	29
Reflection tracking	± 0.08	± 0.08	± 0.04	± 0.04	± 0.05	± 0.06	± 0.08	± 0.08
Transmission tracking	± 0.148	± 0.095	± 0.051	± 0.065	± 0.093	± 0.108	± 0.123	± 0.166

Transmission uncertainty (magnitude and phase)



Reflection uncertainty (magnitude and phase)

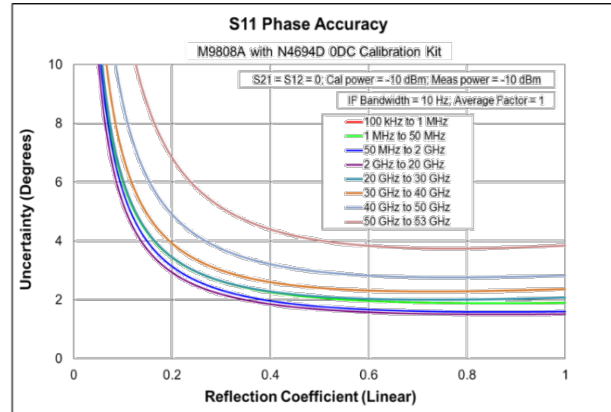
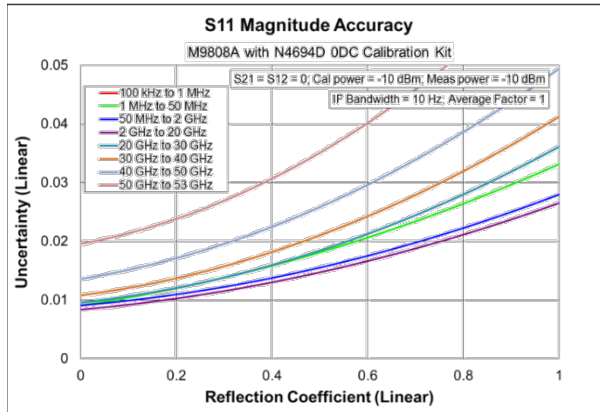

Uncorrected System Performance

Table 7. Uncorrected error terms (dB)¹ – Specification

M9800A, M9801A, M9802A, M9803A, M9804A

Description	Directivity	Source match	Load match	Transmission tracking	Reflection tracking	Crosstalk
300 kHz to 10 MHz	20	20	15	--	--	--
10 MHz to 1.5 GHz	25	25	17	--	--	--
1.5 GHz to 3 GHz	25	25	16	--	--	--
3 GHz to 6 GHz	25	25	11	--	--	--
6 GHz to 10 GHz	20	20	11	--	--	--
10 GHz to 16 GHz	15	15	11	--	--	--
16 GHz to 20 GHz	15	15	8	--	--	--

M9805A, M9806A, M9807A, M9808A

Description	Directivity	Source match	Load match	Transmission tracking	Reflection tracking	Crosstalk
300 kHz to 1 MHz	20	20	1	--	--	--
1 MHz to 3 MHz	20	20	14	--	--	--
3 MHz to 10 MHz	20	20	17	--	--	--
10 MHz to 4 GHz	25	25	17	--	--	--
4 GHz to 6 GHz	25	25	12	--	--	--
6 GHz to 10 GHz	20	20	12	--	--	--
10 GHz to 20 GHz	15	15	9	--	--	--
20 GHz to 27 GHz	15	15	8	--	--	--
27 GHz to 40 GHz	15	15	5	--	--	--
40 GHz to 50 GHz	15	15	8	--	--	--
50 GHz to 53 GHz	10	10	5	--	--	--

1. Specifications apply to following conditions: Factory correction is turned on. Cable loss not included in transmission tracking.

Table 8. Uncorrected error terms (dB) – Typical

M9800A, M9801A, M9802A, M9803A, M9804A

Description	Directivity	Source match	Load match	Transmission tracking	Reflection tracking	Crosstalk
9 kHz to 30 kHz	40	40	5	± 0.5	± 0.5	-110
30 kHz to 100 kHz	40	40	10	± 0.5	± 0.5	-110
100 kHz to 300 kHz	40	40	18	± 0.2	± 0.2	-120
300 kHz to 3 MHz	40	40	23	± 0.2	± 0.2	-120
3 MHz to 10 MHz	40	40	23	± 0.2	± 0.2	-139
10 MHz to 50 MHz	40	40	23	± 0.2	± 0.2	-147 ¹
50 MHz to 1.5 GHz	40	40	23	± 0.2	± 0.2	-150
1.5 GHz to 3 GHz	40	40	20	± 0.2	± 0.2	-150
3 GHz to 4.5 GHz	40	40	15	± 0.2	± 0.2	-149
4.5 GHz to 6 GHz	40	40	15	± 0.2	± 0.2	-147
6 GHz to 9 GHz	35	35	15	± 0.3	± 0.3	-146
9 GHz to 10 GHz	35	35	15	± 0.3	± 0.3	-142
10 GHz to 13 GHz	35	35	15	± 0.5	± 0.5	-142
13 GHz to 16 GHz	35	35	15	± 0.5	± 0.5	-140
16 GHz to 20 GHz	35	35	12	± 0.5	± 0.5	-137

M9805A, M9806A, M9807A, M9808A

Description	Directivity	Source match	Load match	Transmission tracking	Reflection tracking	Crosstalk
100 kHz to 300 kHz	40	40	2	± 0.5	± 0.5	-106
300 kHz to 500 kHz	40	40	2	± 0.5	± 0.5	-120
500 kHz to 1 MHz	40	40	2	± 0.5	± 0.5	-130
1 MHz to 3 MHz	40	40	16	± 0.5	± 0.5	-130
3 MHz to 10 MHz	40	40	20	± 0.5	± 0.5	-138
10 MHz to 50 MHz	40	40	20	± 0.2	± 0.2	-147 ¹
50 MHz to 4 GHz	40	40	20	± 0.2	± 0.2	-150
4 GHz to 6 GHz	40	40	15	± 0.2	± 0.2	-150
6 GHz to 8 GHz	35	35	15	± 0.2	± 0.2	-150
8 GHz to 10 GHz	35	35	15	± 0.2	± 0.2	-147
10 GHz to 16 GHz	35	35	11	± 0.3	± 0.3	-147
16 GHz to 20 GHz	35	35	11	± 0.3	± 0.3	-143
20 GHz to 24 GHz	25	25	10	± 0.3	± 0.3	-143
24 GHz to 26 GHz	25	25	10	± 0.3	± 0.3	-141
26 GHz to 27 GHz	25	25	10	± 0.3	± 0.3	-137
27 GHz to 35 GHz	25	25	7	± 0.3	± 0.3	-137
35 GHz to 40 GHz	25	25	7	± 0.3	± 0.3	-134
40 GHz to 45 GHz	20	20	11	± 0.5	± 0.5	-132
45 GHz to 50 GHz	20	20	11	± 0.5	± 0.5	-115
50 GHz to 53 GHz	15	15	8	± 1	± 1	-101

1. It may typically be degraded at 25 MHz.

Test Port Output ¹

Table 9. Frequency resolution, accuracy, stability

All models

Description	Specification	Typical
Frequency resolution	1 Hz	--
Frequency accuracy	± 7 ppm (25 ± 5 °C)	--
Frequency stability	--	± 7 ppm ² ± 3 ppm/year maximum ³

1. The specifications do not apply to parallel measurements of multiple devices under test (DUT).

2. 0 to 50 °C. Assumes no variation in time.

3. Assumes no variation in temperature.

Table 10. Maximum output port power (dBm)

M9800A, M9801A, M9802A, M9803A, M9804A

Description	Specification	Typical
9 kHz to 100 kHz	0	+2
100 kHz to 10 MHz	+5	+7
10 MHz to 4.5 GHz	+10	+13
4.5 GHz to 6.5 GHz	+10	+12
6.5 GHz to 9 GHz	+9	+12
9 GHz to 16 GHz	+7	+10
16 GHz to 20 GHz	+4	+7

M9805A, M9806A, M9807A, M9808A

Description	Specification	Typical
100 kHz to 300 kHz	-2	+1
300 kHz to 1 MHz	+7	+10
1 MHz to 17 GHz	+10	+13
17 GHz to 20 GHz	+7	+11
20 GHz to 24 GHz	+5	+11
24 GHz to 30 GHz	+5	+8
30 GHz to 38 GHz	+2	+8
38 GHz to 45 GHz	+2	+5
45 GHz to 50 GHz	-5	0
50 GHz to 53 GHz	-23	-12

Table 11. Power sweep range (dBm) ¹

M9800A, M9801A, M9802A, M9803A, M9804A

Description	Specification	Typical
9 kHz to 100 kHz	--	-60 to +2
100 kHz to 10 MHz	--	-60 to +7
10 MHz to 4.5 GHz	--	-60 to +13
4.5 GHz to 6 GHz	--	-60 to +12
6 GHz to 9 GHz	--	-60 to +12
9 GHz to 16 GHz	--	-60 to +10
16 GHz to 20 GHz	--	-60 to +7

M9805A, M9806A, M9807A, M9808A

Description	Specification	Typical
100 kHz to 300 kHz	--	-60 to +1
300 kHz to 1 MHz	--	-60 to +10
1 MHz to 17 GHz	--	-60 to +13
17 GHz to 20 GHz	--	-60 to +11
20 GHz to 24 GHz	--	-50 to +11
24 GHz to 38 GHz	--	-50 to +8
38 GHz to 45 GHz	--	-50 to +5
45 GHz to 50 GHz	--	-50 to 0
50 GHz to 53 GHz	--	-50 to -12

1. When set to source power below -50 dBm, spurious related to LO signal may be observed.

Table 12. Power level accuracy (dB)M9800A, M9801A, M9802A, M9803A, M9804A ¹

Description	Specification	Typical
9 kHz to 100 kHz	± 4.0	± 1.0
100 kHz to 15 GHz	± 1.5	± 0.2
15 GHz to 20 GHz	± 2.0	± 0.3

M9805A, M9806A, M9807A, M9808A ²

Description	Specification	Typical
100 kHz to 10 MHz	± 3.0	± 0.5
10 MHz to 15 GHz	± 1.5	± 0.2
15 GHz to 30 GHz	± 2.0	± 0.2
30 GHz to 40 GHz	± 2.5	± 0.3
40 GHz to 50 GHz ³	± 2.5	± 0.5
50 GHz to 53 GHz ³	--	± 1.0

1. At nominal power of 0 dBm, stepped sweep mode.

2. At nominal power of -15 dBm, stepped sweep mode.

3. If using a power sensor (wideband power detector) to measure or calibrate the power level above 45 GHz, an external filter is required to reduce sub-harmonics. Refer to [VNA webhelp](#) for more details.

Table 13. Power level linearity (dB)

M9800A, M9801A, M9802A, M9803A, M9804A ¹

Description	Specification ²	Typical ^{3,4}
9 kHz to 10 GHz	± 0.75	± 1.0
10 GHz to 20 GHz	± 1.0	± 1.0

1. Level linearity given is relative to 0 dBm.
2. Stepped sweep mode. -20 dBm ≤ P ≤ maximum specified power.
3. Stepped sweep mode. -60 dBm ≤ P < -20 dBm.
4. Swept sweep mode. -60 dBm ≤ P ≤ maximum specified power.

M9805A, M9806A, M9807A, M9808A ¹

Description	Specification ²	Typical
100 kHz to 10 GHz	± 0.75	± 1.0 ^{3,5}
10 GHz to 20 GHz	± 1.0	± 1.0 ^{3,5}
20 GHz to 50 GHz	± 2.0	± 1.0 ^{4,6}

1. Level linearity given is relative to -15 dBm.
2. Stepped sweep mode. -20 dBm ≤ P ≤ maximum specified power.
3. Swept sweep mode. -60 dBm ≤ P ≤ maximum specified power.
4. Swept sweep mode. -65 dBm ≤ P ≤ maximum specified power.
5. Stepped sweep mode. -60 dBm ≤ P < -20 dBm.
6. Stepped sweep mode. -50 dBm ≤ P < -20 dBm.

Table 14. 2nd and 3rd harmonics at 0 dBm (dBc) ¹

M9800A, M9801A, M9802A, M9803A, M9804A

Description	Specification	Typical
30 kHz to 10 MHz	--	-20
10 MHz to 20 GHz	--	-25

M9805A, M9806A, M9807A, M9808A

Description	Specification	Typical
300 kHz to 1 MHz	--	-20
1 MHz to 20 GHz	--	-25
20 GHz to 25 GHz	--	-17
25 GHz to 40 GHz	--	-20
40 GHz to 47 GHz	--	-15
47 GHz to 53 GHz	--	-17

1. Listed frequency is fundamental frequency.

Table 15. Sub-harmonics at nominal power (dBc) ¹M9800A, M9801A, M9802A, M9803A, M9804A ²

Description	Specification	Typical
9 kHz to 10 MHz	--	-50
10 MHz to 20 GHz	--	-35

M9805A, M9806A, M9807A, M9808A ²

Description	Specification	Typical
100 kHz to 10 GHz	--	-50
10 GHz to 20 GHz	--	-35
20 GHz to 40 GHz	--	-30
40 GHz to 47 GHz	--	-20
47 GHz to 50 GHz	--	-10
50 GHz to 53 GHz	--	-2

1. Listed frequency is fundamental frequency.
2. Tested at power of 0 dBm.
3. Tested at power of -15 dBm.

Table 16. Non-harmonic spurs at nominal power (dBc) ¹

M9800A, M9801A, M9802A, M9803A, M9804A

Description	Specification	Typical
9 kHz to 10 GHz	--	-50
10 GHz to 20 GHz	--	-45

M9805A, M9806A, M9807A, M9808A

Description	Specification	Typical
100 kHz to 10 GHz	--	-50
10 GHz to 20 GHz	--	-45
20 GHz to 53 GHz	--	-35

1. Listed frequency is fundamental frequency. Includes spurious related to LO signal and frac-N.

Table 17. Nominal power (preset power level)

Description	Specification
M9800A, M9801A, M9802A, M9803A, M9804A	0 dBm
M9805A, M9806A, M9807A, M9808A	-15 dBm

Table 18. Power resolution, maximum/minimum settable power

Description	Specification	Typical
Settable resolution	--	0.01 dB
Maximum settable power	--	+30 dBm
Minimum settable power	--	-100 dBm

Test Port Input

Table 19. Test port noise floor (dBm) ¹

M9800A, M9801A, M9802A, M9803A, M9804A

Description	Specification	Typical
9 kHz to 100 kHz	-101	-109
100 kHz to 300 kHz	-112	-119
300 kHz to 1 MHz	-120	-127
1 MHz to 10 MHz	-125	-132
10 MHz to 50 MHz ²	-127	-134
50 MHz to 3 GHz	-130	-137
3 GHz to 4.5 GHz	-130	-136
4.5 GHz to 6.5 GHz	-130	-135
6.5 GHz to 9 GHz	-127	-134
9 GHz to 14 GHz	-126	-132
14 GHz to 16 GHz	-123	-130
16 GHz to 20 GHz	-122	-130

M9805A, M9806A, M9807A, M9808A

Description	Specification	Typical
100 kHz to 300 kHz	-97	-105
300 kHz to 500 kHz	-97	-110
500 kHz to 1 MHz	-110	-120
1 MHz to 10 MHz	-115	-124
10 MHz to 50 MHz ²	-127	-133
50 MHz to 200 MHz	-130	-133
200 MHz to 3 GHz	-130	-137
3 GHz to 6.5 GHz	-130	-135
6.5 GHz to 9 GHz	-128	-134
9 GHz to 17 GHz	-127	-133
17 GHz to 25 GHz	-125	-131
25 GHz to 30 GHz	-122	-129
30 GHz to 45 GHz	-120	-127

45 GHz to 50 GHz	-105	-115
50 GHz to 53 GHz	-95	-113

1. Noise floor in a 10 Hz IF Bandwidth. Measured with 1 kHz IF bandwidth for 9 kHz to < 100 kHz, and 30 kHz IF bandwidth for 100 kHz to 53 GHz. Test port terminated. Test port terminated.
2. It may typically be degraded at 25 MHz.

Table 20. Receiver compression at test port ¹

M9800A, M9801A, M9802A, M9803A, M9804A

Description	Input power at test port (dBm)	Specification		Typical	
		Magnitude (dB)	Phase (°)	Magnitude (dB)	Phase (°)
9 kHz to 100 kHz	0	0.5	5	0.10	1.5
100 kHz to 10 MHz	+5	0.2	5	0.05	1.0
10 MHz to 6.5 GHz	+10	0.2	5	0.05	1.0
6.5 GHz to 9 GHz	+9	0.2	5	0.05	1.0
9 GHz to 16 GHz	+7	0.2	5	0.05	1.0
16 GHz to 20 GHz	+4	0.2	5	0.05	1.0

M9805A, M9806A, M9807A, M9808A

Description	Input power at test port (dBm)	Specification		Typical	
		Magnitude (dB)	Phase (°)	Magnitude (dB)	Phase (°)
100 kHz to 300 kHz	-2	0.2	5	0.10	1.0
300 kHz to 1 MHz	+7	0.2	5	0.10	1.0
1 MHz to 17 GHz	+10	0.2	5	0.05	1.0
17 GHz to 20 GHz	+7	0.2	5	0.05	1.0
20 GHz to 30 GHz	+5	0.2	5	0.05	1.0
30 GHz to 45 GHz	+2	0.2	5	0.05	1.0
45 GHz to 50 GHz	-5	0.2	5	0.05	1.0
50 GHz to 53 GHz	-23	0.2	5	0.05	1.0

1. Tested with receiver gain AUTO. (High receiver attenuator is selected for measurements)

Table 21. Trace noise magnitude (dB rms) ¹

M9800A, M9801A, M9802A, M9803A, M9804A

Description	Specification	Typical
9 kHz to 30 kHz	0.005	0.0025
30 kHz to 100 kHz	0.003	0.001
100 kHz to 6 GHz ²	0.0015	0.0005
6 GHz to 10 GHz	0.002	0.0006
10 GHz to 20 GHz	0.003	0.001

M9805A, M9806A, M9807A, M9808A

Description	Specification	Typical
100 kHz to 300 kHz	0.005	0.002
300 kHz to 1 MHz	0.003	0.001
1 MHz to 4.5 GHz ²	0.0015	0.0005
4.5 GHz to 10 GHz	0.0015	0.0007
10 GHz to 17 GHz	0.002	0.001
17 GHz to 30 GHz	0.003	0.0013
30 GHz to 45 GHz	0.006	0.0022
45 GHz to 50 GHz	0.018	0.006

1. Transmission and reflection trace noise in a 1 kHz IF bandwidth for < 10 MHz, 10 kHz IF bandwidth for ≥ 10 MHz. At maximum specified power.
2. It may typically be degraded at particular frequencies such as 25 MHz, 54 MHz, 58.5 MHz, 108 MHz, 120 MHz or 132 MHz, 143 MHz, or 156 MHz.

Table 22. Trace noise phase (degree rms)¹

M9800A, M9801A, M9802A, M9803A, M9804A

Description	Specification	Typical
9 kHz to 30 kHz	0.07	0.025
30 kHz to 100 kHz	0.05	0.017
100 kHz to 300 kHz	0.035	0.006
300 kHz to 6 GHz ²	0.01	0.003
6 GHz to 10 GHz	0.02	0.006
10 GHz to 13.5 GHz	0.03	0.006
13.5 GHz to 20 GHz	0.03	0.01

M9805A, M9806A, M9807A, M9808A

Description	Specification	Typical
100 kHz to 300 kHz	0.07	0.015
300 kHz to 1 MHz	0.03	0.01
1 MHz to 6 GHz ²	0.02	0.003
6 GHz to 10 GHz	0.02	0.004
10 GHz to 17 GHz	0.02	0.006
17 GHz to 30 GHz	0.02	0.01
30 GHz to 45 GHz	0.04	0.018
45 GHz to 50 GHz	0.18	0.03

1. Transmission and reflection trace noise in a 1 kHz IF bandwidth for < 10 MHz, 10 kHz IF bandwidth for ≥ 10 MHz. At maximum specified power.
2. It may typically be degraded at particular frequencies such as 25 MHz, 54 MHz, 58.5 MHz, 108 MHz, 120 MHz or 132 MHz, 143 MHz, or 156 MHz.

Table 23. Temperature stability – Typical

M9800A, M9801A, M9802A, M9803A, M9804A

Description	Magnitude (dB/°C)	Phase (degree/°C)
9 kHz to 300 kHz	0.03	0.2
300 kHz to 4.5 GHz	0.005	0.1
4.5 GHz to 6 GHz	0.01	0.1
6 GHz to 6.5 GHz	0.01	0.2
6.5 GHz to 10 GHz	0.015	0.2
10 GHz to 14 GHz	0.015	0.3
14 GHz to 20 GHz	0.02	0.4

M9805A, M9806A, M9807A, M9808A

Description	Magnitude (dB/°C)	Phase (degree/°C)
100 kHz to 1 MHz	0.03	1.0
1 MHz to 10 MHz	0.005	0.2
10 MHz to 4.5 GHz	0.005	0.1
4.5 GHz to 10 GHz	0.01	0.1
10 GHz to 20 GHz	0.01	0.2
20 GHz to 30 GHz	0.01	0.25
30 GHz to 40 GHz	0.01	0.3
40 GHz to 50 GHz	0.03	0.8
50 GHz to 53 GHz	0.06	1.0

Table 24. Damage input level

All models

Description	
Damage Input Level	+27 dBm or \pm 35 VDC (Warranted)

Dynamic Accuracy

Accuracy of the test port input power relative to the reference input power level. Measured with 10 Hz IF bandwidth.

Dynamic accuracy¹ – specification

M9800A, M9801A, M9802A, M9803A, M9804A

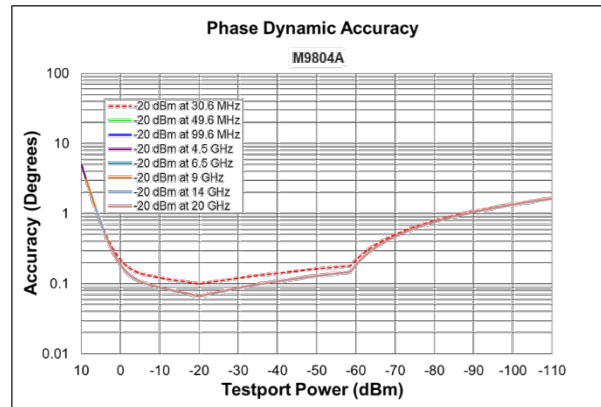
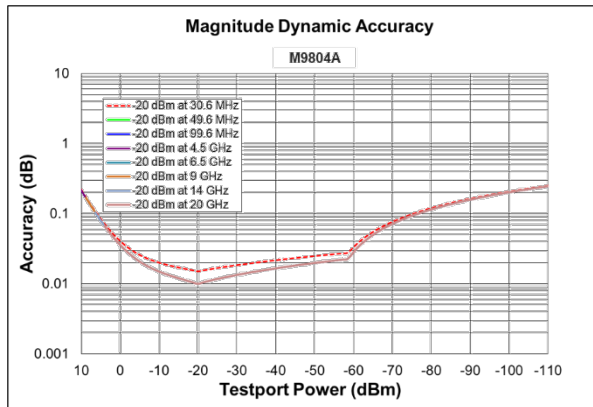

M9805A, M9806A, M9807A, M9808A

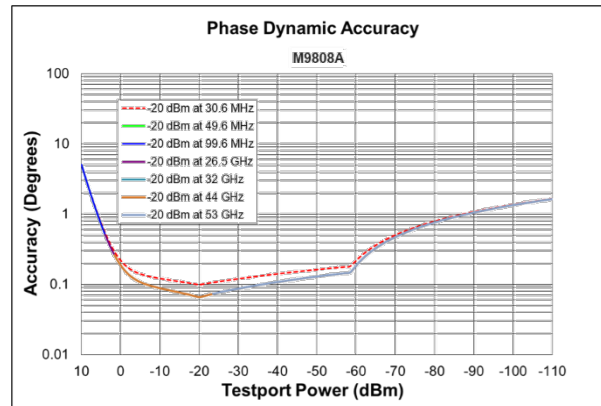
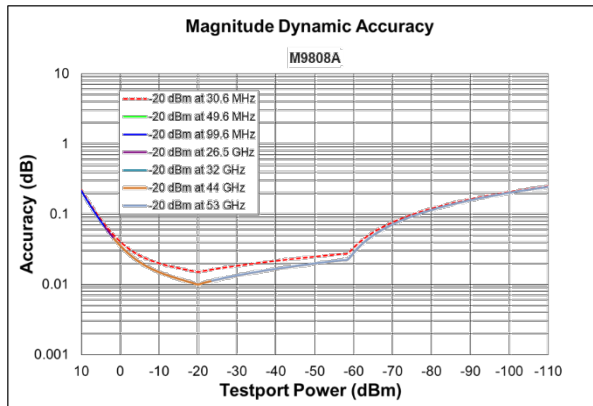

- Dynamic accuracy is verified with the following measurements:
 - Compression over frequency.
 - IF linearity using a reference level of -20 dBm for an input power range of 0 to -60 dBm. Tested at three single frequencies (30.6MHz, 49.6MHz and 99.6MHz) to cover the whole frequency range. The VNA receiver is linear by design when signal levels are below -60 dBm. For more details, refer to [VNA Receiver Dynamic Accuracy Specifications and Uncertainties](#).
- Download Uncertainty Calculator from http://www.keysight.com/find/na_calculator to generate the curves of dynamic accuracy.

Spectrum Analysis (with Option 090/190 and S95090B)

This section provides specifications for the spectrum analysis Option 090/190 on the M980xA Series PXIe VNA. S95090B Software is required to enable spectrum analysis functionality of the M980xA.

Table 25. Frequency specifications

All models

Description	Specification	Typical
Frequency reference ¹		
Accuracy	--	± [(time since last adjustment x aging rate) + temperature stability + calibration accuracy], typical
Aging rate	--	± 3 ppm/year maximum, typical
Temperature stability	--	± 7 ppm (0 to 50 °C)
Achievable initial calibration accuracy	± 7 ppm (25 ± 5 °C)	--
Frequency readout accuracy (Start, Stop, Center, Marker)	--	± [(readout frequency x frequency reference accuracy) + (< 1% x RBW)], nominal
Frequency span		
Minimum/Maximum	Analyzer's full span	--
Resolution	1 Hz	--
Sweep (Trace) point range	11 to 100,003	--
Resolution bandwidth (RBW)		
Range (-3 dB bandwidth)	10 Hz to 3 MHz in 10% steps	--
Bandwidth range accuracy	--	± 1%, all RBW, except below 100 MHz with 3 MHz RBW
Selectivity (-60 dB/-3 dB)	--	Gaussian: 4.5:1, Flat top: 2.47:1, Kaiser: 3.82:1, Blackman: 3.58:1
Video bandwidth (VBW)		
Range	10 Hz to 3 MHz	--

1. Frequency reference accuracy can be improved by using external frequency reference with better accuracy.

Table 26. Time specifications

All models

Description	Specification	Supplemental information
Sweep time and triggering		
Sweep time range	Auto	--
Trigger types	Continuous, Single, Group, Manual, External	--
Trigger delay range	0 to 3 s	--
Trigger delay resolution	1 µs	--

Measuring and display update rate (milliseconds) ¹		
20 MHz Span, 3 kHz RBW, 3 kHz VBW	--	63
100 MHz Span, Auto RBW, Auto VBW	--	62
1 GHz Span, 3 kHz RBW, 3 kHz VBW	--	198
1 GHz Span, 300 kHz RBW, 300 kHz VBW	--	64
10 GHz Span, 3 kHz RBW, 3 kHz VBW	--	1826
10 GHz Span, 300 kHz RBW, 300 kHz VBW	--	252
10 MHz to 20 GHz, RBW/VBW = 1 MHz	--	314
10 MHz to 50 GHz, RBW/VBW = 1 MHz	--	332

1. Measured with a 2-port module with firmware revision A.16.70.

Table 27. Amplitude accuracy and range specifications

All models

Description	Specification
Amplitude range	
Measurement range	DANL to maximum input level
Input attenuator range	High attenuation or Low attenuation
Maximum safe input level	+27 dBm
Display range	
Log scale	0.001 to 500 dB/div in 0.001 steps
Linear scale	10 divisions (default)
Scale units	dBm, mW
Trace detectors types	Average, Sample, Peak, Normal, Negative Peak, Peak sample, Peak average

Table 28. SA detector accuracy (dB) ¹ – Specifications

M9800A, M9801A, M9802A, M9803A, M9804A

Description	Specification
9 kHz to 10 MHz	± 0.15
10 MHz to 20 GHz ²	± 0.1

M9805A, M9806A, M9807A, M9808A

Description	Specification
100 kHz to 10 MHz	± 0.15
10 MHz to 20 GHz	± 0.1
20 GHz to 53 GHz	± 0.15

1. With high attenuation. SA detector accuracy is residual error of IF response calibration. IF response is characterized with M980xA's standard measurement class after power and S-parameter calibration. Therefore, the SA total absolute amplitude accuracy includes power meter, S-parameter and SA detector accuracies. Add input attenuation switching uncertainty if receiver attenuator is changed after user calibration.

2. Tested up to 19.99 GHz.

Table 29. Input attenuation switching uncertainty (dB) – Supplemental information

M9800A, M9801A, M9802A, M9803A, M9804A

Description	Supplemental information
9 kHz to 50 MHz	± 0.5
50 MHz to 20 GHz	± 1.0

M9805A, M9806A, M9807A, M9808A

Description	Supplemental information
100 kHz to 50 MHz	± 0.5
50 MHz to 53 GHz	± 1.0

Table 30. Input VSWR ¹ – Specifications

M9800A, M9801A, M9802A, M9803A, M9804A

Description	Specification
300 kHz to 10 MHz	1.433
10 MHz to 1.5 GHz	1.329
1.5 GHz to 3 GHz	1.377
3 GHz to 10 GHz	1.785
10 GHz to 16 GHz	1.785
16 GHz to 20 GHz	2.323

M9805A, M9806A, M9807A, M9808A

Description	Specification
1 MHz to 3 MHz	1.499
3 MHz to 4 GHz	1.329
4 GHz to 10 GHz	1.671
10 GHz to 20 GHz	2.100
20 GHz to 27 GHz	2.323
27 GHz to 40 GHz	3.570
40 GHz to 50 GHz	2.323
50 GHz to 53 GHz	3.570

1. Calculated by load match of uncorrected error terms (Table 10). $VSWR = \frac{1+10^{(-1+load\ match/20)}}{1-10^{(-1+load\ match/20)}}$

Table 31. Other amplitude accuracy – Supplemental information

All models

Description	Supplemental information
RBW switching uncertainty	0.02 dB
Display scale fidelity	See dynamic accuracy specification. Specification applied to SA measurement class with user calibration between -10 dBm and -40 dBm input power and measurement between +10 dBm and -120 dBm input power.

Table 32. Spurious response – Supplemental information

All models

Description	Supplemental information
Image response	Mostly eliminated. Intermittent image response may be seen when making multi-tone or modulated signal measurements.
LO related spurious	Eliminated

Table 33. Displayed Average Noise Level (DANL) at test ports with low attenuation (dBm/Hz) ¹ – Specifications

M9800A, M9801A, M9802A, M9803A, M9804A

Description	Specification	Typical
9 kHz to 100 kHz	-114	-122
100 kHz to 300 kHz	-125	-132
300 kHz to 1 MHz	-133	-138
1 MHz to 10 MHz	-138	-145
10 MHz to 100 MHz	-140	-147
100 MHz to 4.5 GHz	-144	-150
4.5 GHz to 6.5 GHz	-144	-149
6.5 GHz to 9 GHz	-141	-148
9 GHz to 14 GHz	-140	-146
14 GHz to 16 GHz	-137	-144
16 GHz to 20 GHz	-136	-144

M9805A, M9806A, M9807A, M9808A

Description	Specification	Typical
100 kHz to 300 kHz	-110	-118
300 kHz to 500 kHz	-110	-120
500 kHz to 1 MHz ²	-123	-130
1 MHz to 10 MHz	-128	-134
10 MHz to 100 MHz	-136	-142
100 MHz to 200 MHz	-144	-146
200 MHz to 3 GHz	-144	-150
3 GHz to 6.5 GHz	-144	-148
6.5 GHz to 9 GHz	-142	-147
9 GHz to 17 GHz	-141	-146
17 GHz to 20 GHz	-139	-146
20 GHz to 25 GHz	-139	-143
25 GHz to 30 GHz	-136	-143
30 GHz to 45 GHz	-134	-141
45 GHz to 50 GHz	-119	-129
50 GHz to 53 GHz	-109	-127

1. Tested with 1 kHz RBW up to 50 MHz and 10 kHz RBW for above 50 MHz, test port terminated, average detector, averaging type = Log, IF gain = AUTO, image rejection = normal, random LO OFF.
2. A residual spurious response may be observed around 600 kHz.

Table 34. Displayed Average Noise Level (DANL) at test ports with high attenuation (dBm/Hz)¹ – Typical

M9800A, M9801A, M9802A, M9803A, M9804A

Description	Specification	Typical
9 kHz to 100 kHz	--	-100
100 kHz to 300 kHz	--	-110
300 kHz to 1 MHz	--	-116
1 MHz to 10 MHz	--	-116
10 MHz to 100 MHz	--	-116
100 MHz to 4.5 GHz	--	-127
4.5 GHz to 6.5 GHz	--	-127
6.5 GHz to 9 GHz	--	-126
9 GHz to 14 GHz	--	-124
14 GHz to 16 GHz	--	-122
16 GHz to 20 GHz	--	-122

M9805A, M9806A, M9807A, M9808A

Description	Specification	Typical
100 kHz to 300 kHz	--	-96
300 kHz to 500 kHz	--	-98
500 kHz to 1 MHz ²	--	-108
1 MHz to 10 MHz	--	-112
10 MHz to 100 MHz	--	-112
100 MHz to 200 MHz	--	-124
200 MHz to 3 GHz	--	-128
3 GHz to 6.5 GHz	--	-126
6.5 GHz to 9 GHz	--	-125
9 GHz to 20 GHz	--	-124
20 GHz to 30 GHz	--	-121
30 GHz to 45 GHz	--	-119
45 GHz to 50 GHz	--	-107
50 GHz to 53 GHz	--	-105

1. Tested with 1 kHz RBW up to 50 MHz and 10 kHz RBW for above 50 MHz, test port terminated, average detector, averaging type = Log, IF gain = AUTO, image rejection = normal, random LO OFF.

2. A residual spurious response may be observed around 600 kHz.

Table 35. Second harmonic distortion with high attenuation¹ – Supplemental information

M9800A, M9801A, M9802A, M9803A, M9804A

Description	SHI (dBm)
50 MHz to 1 GHz	+30
1 GHz to 4 GHz	+38
4 GHz to 10 GHz	+47

M9805A, M9806A, M9807A, M9808A

Description	SHI (dBm)
50 MHz to 1 GHz	+30
1 GHz to 4 GHz	+38
4 GHz to 10 GHz	+47
10 GHz 15 GHz	+44
15 GHz to 26.5 GHz	+40

1. Tested with 0 dBm for 50 MHz to 10 GHz, and -5 dBm for 10 GHz to 26.5 GHz input at test port, 10 MHz tone separations.

Table 36. Second harmonic distortion with low attenuation ¹ – Supplemental information

M9800A, M9801A, M9802A, M9803A, M9804A

Description	SHI (dBm)
50 MHz to 1 GHz	+10
1 GHz to 4 GHz	+20
4 GHz to 10 GHz	+30

M9805A, M9806A, M9807A, M9808A

Description	SHI (dBm)
50 MHz to 1 GHz	+10
1 GHz to 4 GHz	+20
4 GHz to 10 GHz	+30
10 GHz to 15 GHz	+26
15 GHz to 20 GHz	+21
20 GHz to 26.5 GHz	+16

1. Tested with -25 dBm input at test port, 10 MHz tone separations.

Table 37. Third order intermodulation distortion with high attenuation ¹ – Characteristic

M9800A, M9801A, M9802A, M9803A, M9804A

Description	Distortion (dBc)	TOI (dBm)
50 MHz to 200 MHz	-40	+20
200 MHz to 2 GHz	-44	+22
2 GHz to 5 GHz	-46	+23
5 GHz to 10 GHz	-50	+25
10 GHz to 15 GHz	-60	+25
15 GHz to 20 GHz	-54	+22

M9805A, M9806A, M9807A, M9808A

Description	Distortion (dBc)	TOI (dBm)
50 MHz to 200 MHz	-40	+20
200 MHz to 2 GHz	-44	+22
2 GHz to 5 GHz	-46	+23
5 GHz to 10 GHz	-50	+25
10 GHz to 15 GHz	-56	+23
15 GHz to 20 GHz	-52	+21
20 GHz to 30 GHz	-42	+16

30 GHz to 40 GHz	-48	+14
40 GHz to 53 GHz	-52	+11

1. Tested with 0 dBm for 50 MHz to 10 GHz, -5 dBm for 10 GHz to 30 GHz, -10 dBm for 30 GHz to 40 GHz, and -15 dBm for 40 GHz to 53 GHz input at test port, 10 MHz tone separations.

Table 38. Third order intermodulation distortion with low attenuation¹ – Characteristic

M9800A, M9801A, M9802A, M9803A, M9804A

Description	Distortion (dBc)	TOI (dBm)
50 MHz to 5 GHz	-56	+3
5 GHz to 10 GHz	-52	+1
10 GHz to 20 GHz	-66	+8

M9805A, M9806A, M9807A, M9808A

Description	Distortion (dBc)	TOI (dBm)
50 MHz to 5 GHz	-56	+3
5 GHz to 10 GHz	-52	+1
10 GHz to 20 GHz	-66	+7
20 GHz to 30 GHz	-66	+5
30 GHz to 53 GHz	-66	+2

1. Tested with -25 dBm input at test port, 10 MHz tone separations

DANL and distortion relative to test port level (dB) – Nominal

M9800A, M9801A, M9802A, M9803A, M9804A¹

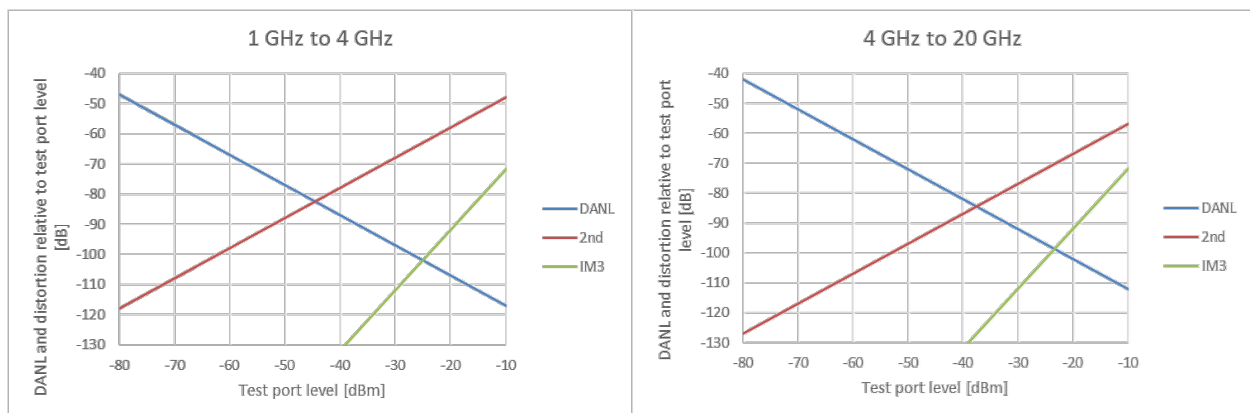

1. With High Attenuation. 2nd harmonic distortion applies up to 10 GHz.

M9805A, M9806A, M9807A, M9808A²

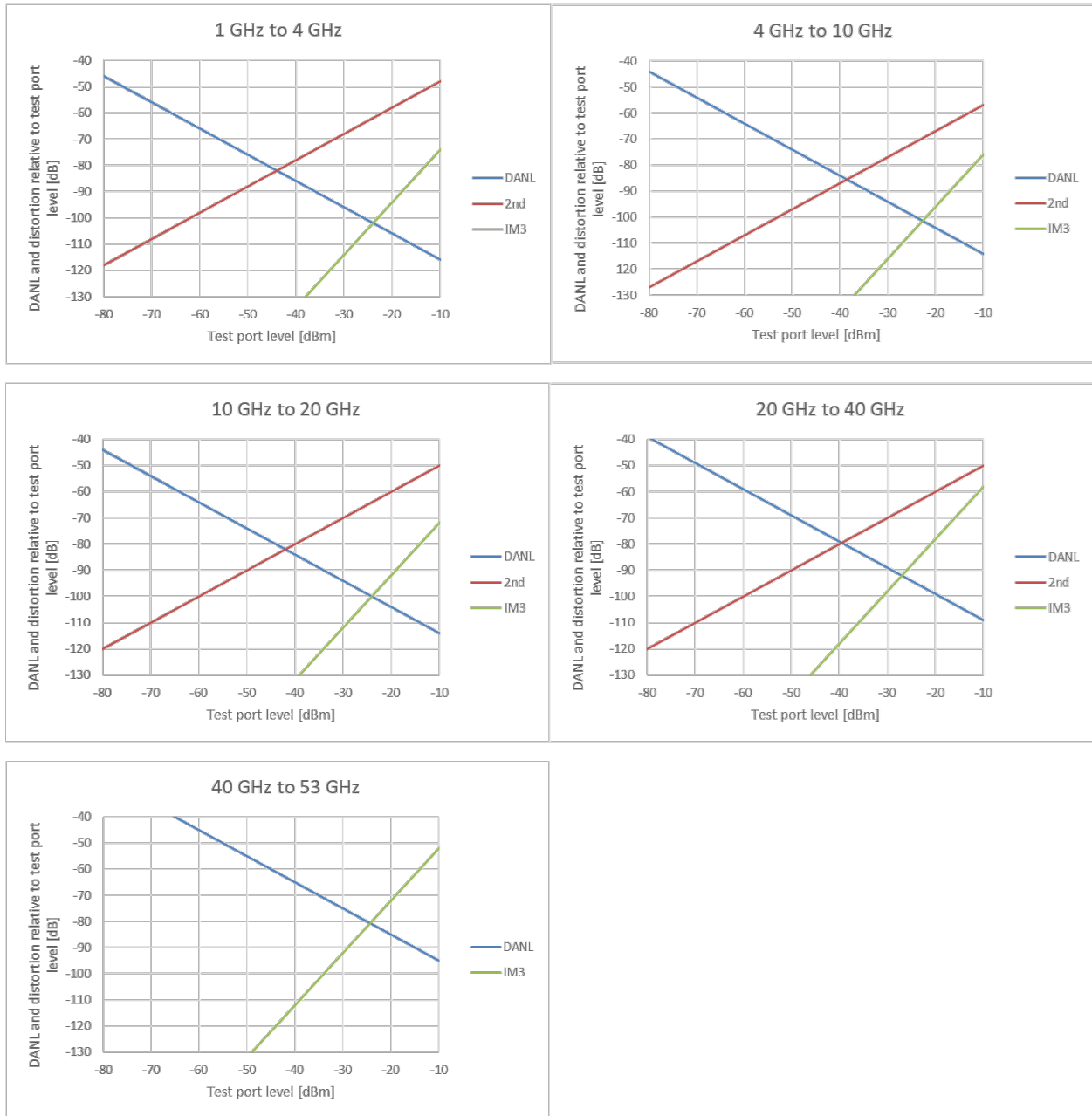

2. With High Attenuation. 2nd harmonic distortion applies up to 26.5 GHz.

Table 39. Receiver phase noise (dBc/Hz) ¹ – Typical

All models

Description	1 kHz	10 kHz	100 kHz	1 MHz	10 MHz
CF = 1 GHz	-103	-103	-103	-128	-130
CF = 3 GHz	-96	-96	-96	-120	-130
CF = 10 GHz	-83	-83	-83	-116	-127
CF = 20 GHz ²	-76	-76	-76	-110	-121

1. At maximum specified power. Spurious signals are excluded. With the SA class, phase noise of VNA's source is equivalent to the receiver phase noise.
2. Tested at 19.99 GHz.

Pulsed-RF Measurements (with Option 021 and S95024B/S95025B)

This section provides specifications for the pulse modulation hardware (Option 021) on the M980xA Series PXIe VNA. The S95024B or S95025B Software is required to enable pulsed-RF measurement functions of the M980xA.

Table 40. Pulse modulation On/Off ratio (dB) – Typical

M9800A, M9801A, M9802A, M9803A, M9804A

Description	Normal mode ¹	Fast mode
9 kHz to 4.5 GHz	80	50
4.5 GHz to 15 GHz	70	40
15 GHz to 20 GHz	70	35

M9805A, M9806A, M9807A, M9808A

Description	Normal mode ¹	Fast mode
100 kHz to 3 GHz	80	50
3 GHz to 8 GHz	80	40
8 GHz to 20 GHz	80	38
20 GHz to 40 GHz	70	30
40 GHz to 50 GHz	70	25

1. At power of > -20 dBm.

Pulse modulation shape examples

M9800A, M9801A, M9802A, M9803A, M9804A

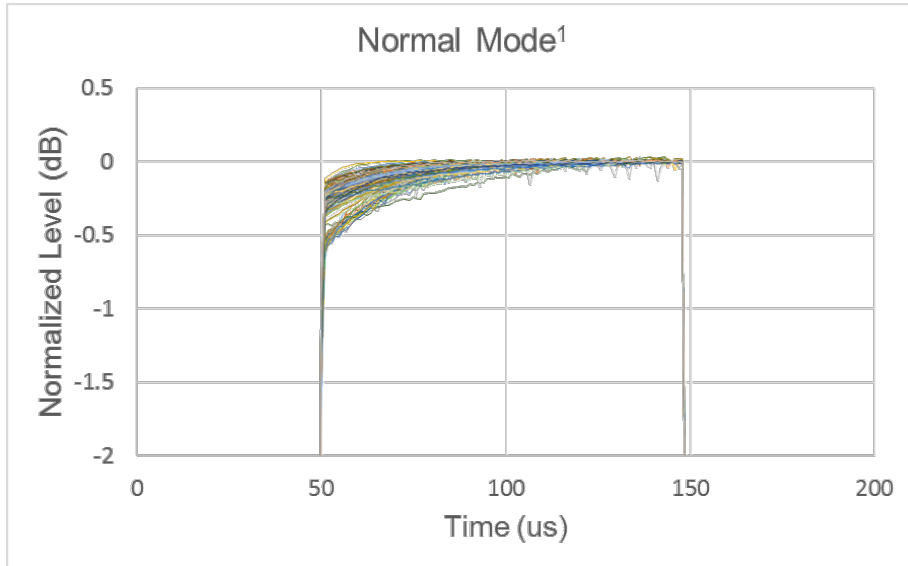

1. Measured with a 500 kHz IF bandwidth, no averaging. With 100 μ s pulse width setting.

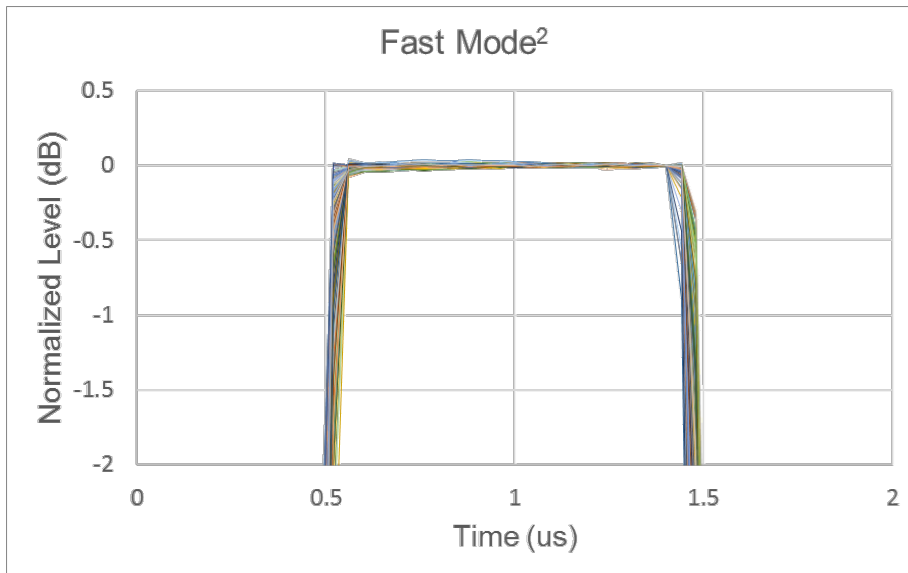

2. Measured with a 15 MHz IF bandwidth, averaging factor of 16 (Average Type = Point). With 1 μ s pulse width setting. S95025B software is required. (Minimum pulse width with S95024B is 50 μ s.)

M9805A, M9806A, M9807A, M9808A

1 GHz to 26.5 GHz

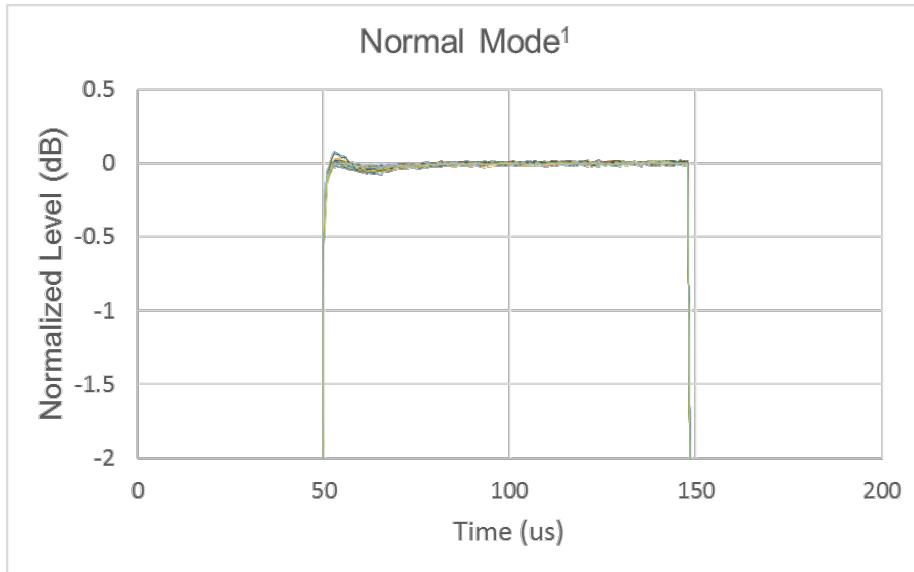

32 GHz

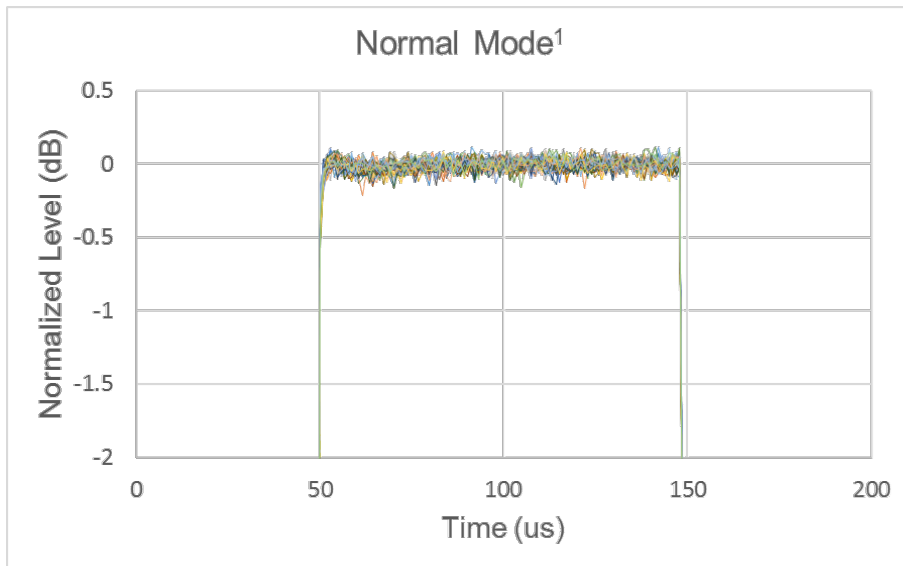

1. Measured with a 500 kHz IF bandwidth, averaging factor of 16 (Average Type = Point). With 100 μ s pulse width setting.

44 GHz

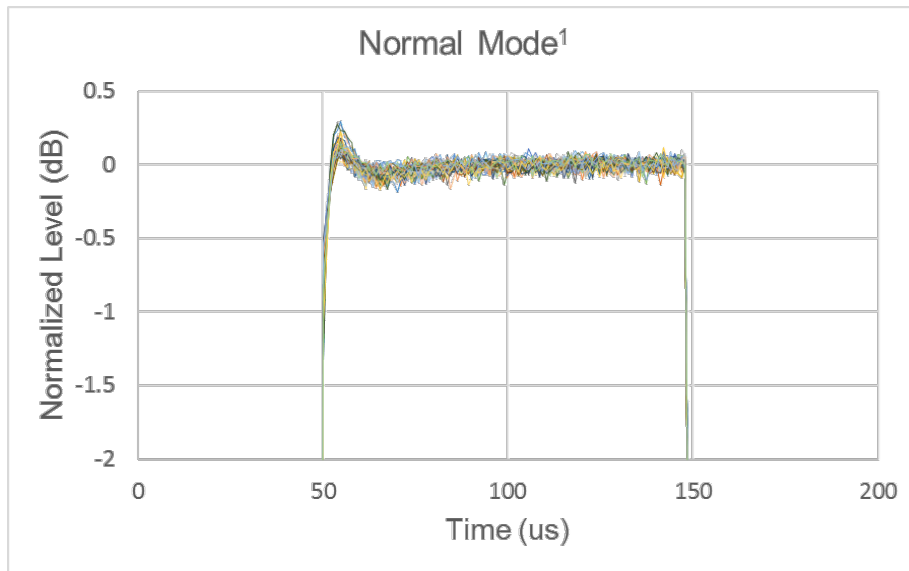

50 GHz

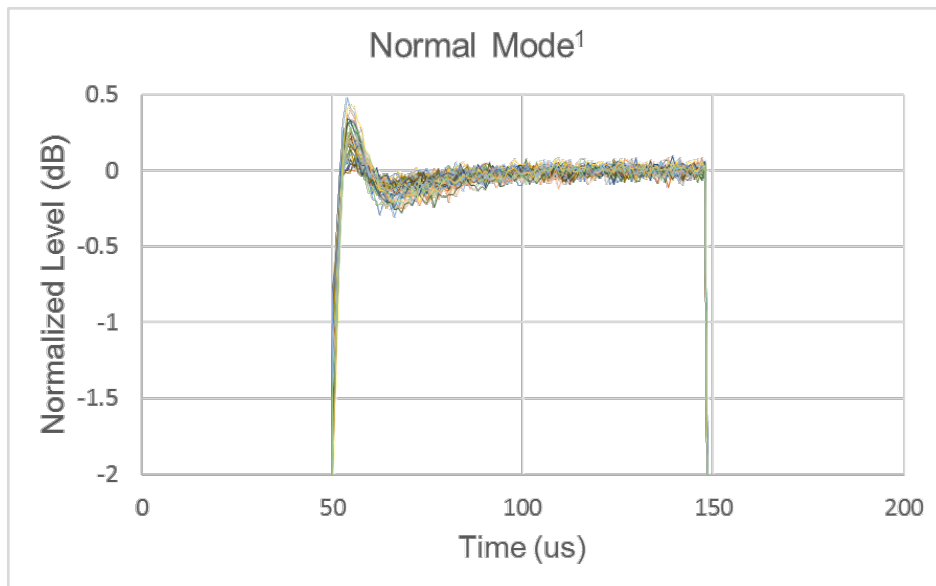

1. Measured with a 500 kHz IF bandwidth, averaging factor of 16 (Average Type = Point). With 100 μ s pulse width setting.

1 GHz to 26.5 GHz

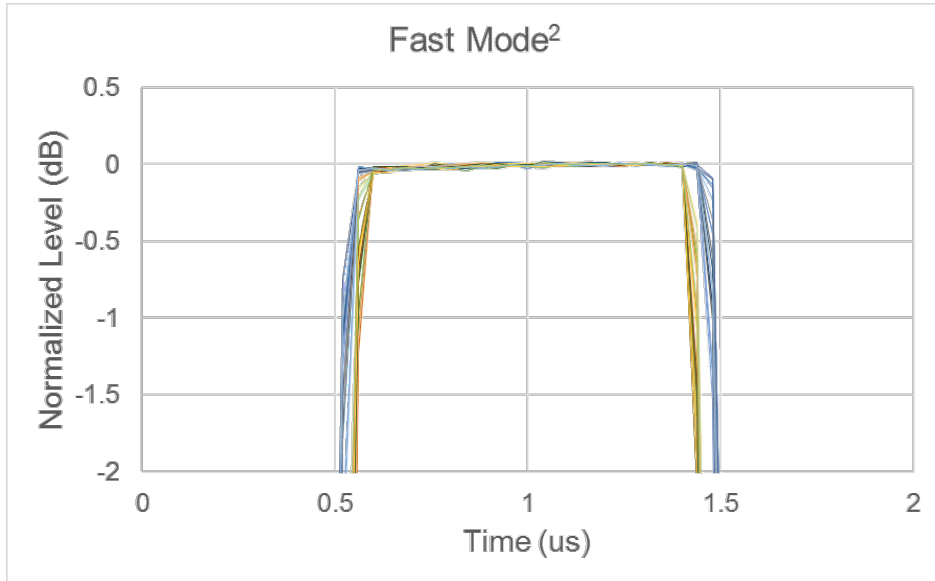

32 GHz

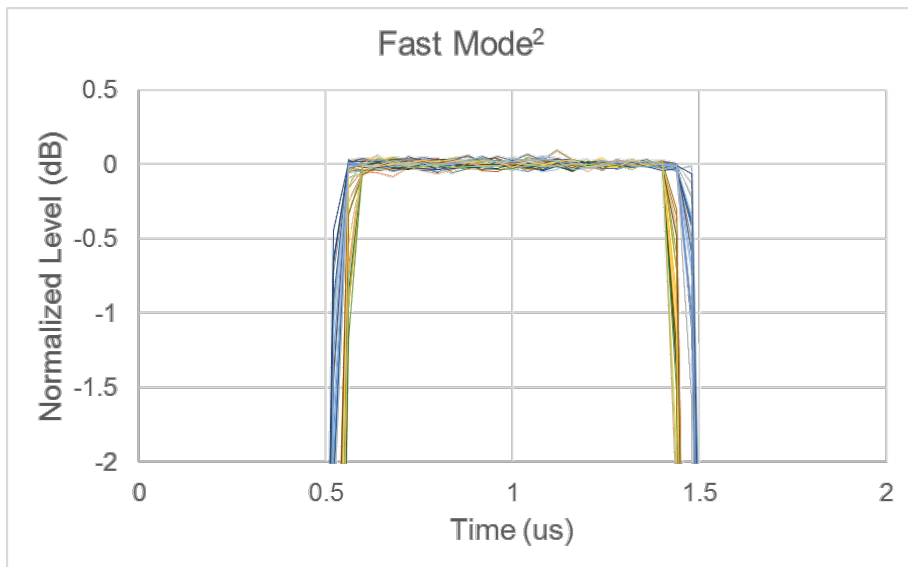

2. Measured with a 15 MHz IF bandwidth, averaging factor of 16 (Average Type = Point). With 1 μ s pulse width setting. S95025B software is required. (Minimum pulse width with S95024B is 50 μ s.)

44 GHz

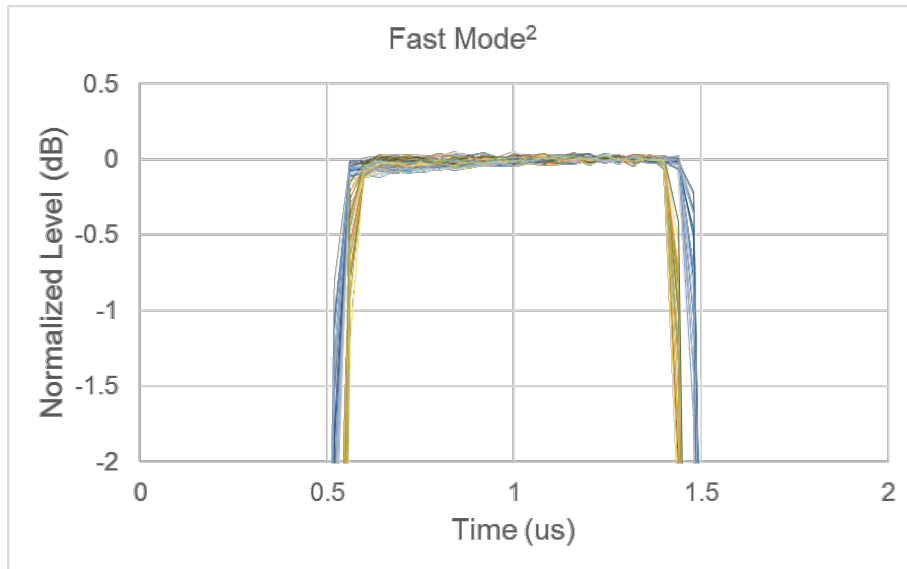

50 GHz

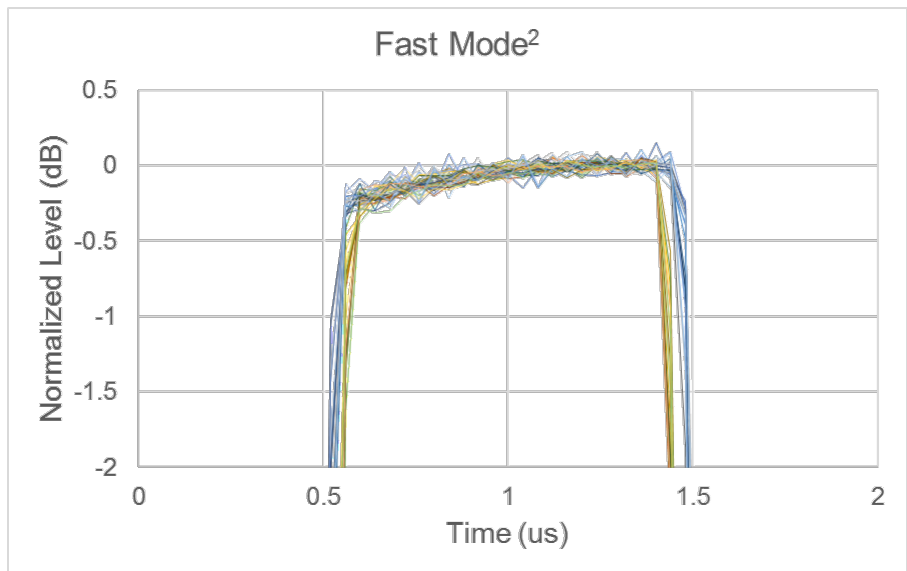

2. Measured with a 15 MHz IF bandwidth, averaging factor of 16 (Average Type = Point). With 1 μ s pulse width setting. S95025B software is required. (Minimum pulse width with S95024B is 50 μ s.)

Table 41. Pulse modulation (source modulators) – Typical

All models

Description	Typical
Minimum pulse width	200 ns
Minimum pulse period	1 μ s
Maximum pulse period	10 s

Enhanced Time Domain Analysis with TDR (S95011B)

This section provides specifications for the enhanced time domain analysis on the M980xA Series PXIe VNA. The S95011B Software is required to enable enhanced time domain analysis functions of the M980xA.

Table 42. Key specifications of enhanced time domain analysis

M9800A, M9801A, M9802A, M9803A, M9804A

Description		M9804A	M9803A	M9802A	M9801A	M9800A
Bandwidth	spec.	20 GHz	14 GHz	9 GHz	6.5 GHz	4.5 GHz
Input impedance	nom.	50 Ω	50 Ω	50 Ω	50 Ω	50 Ω
DC damage level at test port	spec.	35 V	35 V	35 V	35 V	35 V
Maximum test port input voltage (Hot TDR mode)	typ.	1.5 Vpp	1.5 Vpp	1.5 Vpp	1.5 Vpp	1.5 Vpp
TDR stimulus ¹	nom.	Step, Impulse	Step, Impulse	Step, Impulse	Step, Impulse	Step, Impulse
TDR step amplitude ²	nom.	1 mV to 5 V	1 mV to 5 V	1 mV to 5 V	1 mV to 5 V	1 mV to 5 V
TDR step rise time ³ (min) (10% to 90%)	spec.	22.3 ps	31.9 ps	49.6 ps	68.6 ps	99.1 ps
TDR step response resolution in free space ⁴ ($\epsilon_r = 1$) (min)	nom.	3.3 mm	4.8 mm	7.4 mm	10.3 mm	14.9 mm
TDR impulse width (min) ³	spec.	30.2 ps	43.1 ps	67.1 ps	92.9 ps	135 ps
TDR deskew range (max) ⁵ (test cable length)	typ.	50 ns	50 ns	50 ns	50 ns	50 ns
DUT length (max) ⁶	spec.	13.8 μ s	13.8 μ s	13.8 μ s	13.8 μ s	13.8 μ s
TDR stimulus repetition rate (max)	spec.	19.9 MHz	13.9 MHz	8.9 MHz	6.4 MHz	4.4 MHz
RMS noise level ⁷	typ.	60 μ Vrms	60 μ Vrms	60 μ Vrms	60 μ Vrms	60 μ Vrms
Eye diagram data rate (max) ⁸	spec.	16 Gb/s	11.2 Gb/s	7.2 Gb/s	5.2 Gb/s	3.6 Gb/s

M9805A, M9806A, M9807A, M9808A

Description		M9808A	M9807A	M9806A	M9805A
Bandwidth	spec.	53 GHz	44 GHz	32 GHz	26.5 GHz
Input impedance	nom.	50 Ω	50 Ω	50 Ω	50 Ω
DC damage level at test port	spec.	35 V	35 V	35 V	35 V
Maximum test port input voltage (Hot TDR mode)	typ.	1.5 V (100 kHz to 20 GHz) 0.9 V (20 GHz to 30 GHz) 0.7 V (30 GHz to 40 GHz) 0.5 V (40 GHz to 53 GHz)	1.5 V (100 kHz to 20 GHz) 0.9 V (20 GHz to 30 GHz) 0.7 V (30 GHz to 40 GHz) 0.5 V (40 GHz to 44 GHz)	1.5 V (100 kHz to 20 GHz) 0.9 V (20 GHz to 30 GHz) 0.7 V (30 GHz to 32 GHz)	1.5 V (100 kHz to 20 GHz) 0.9 V (20 GHz to 26.5 GHz)
TDR stimulus ¹	nom.	Step, Impulse	Step, Impulse	Step, Impulse	Step, Impulse
TDR step amplitude ²	nom.	1 mV to 5 V	1 mV to 5 V	1 mV to 5 V	1 mV to 5 V
TDR step rise time ³ (min) (10% to 90%)	spec.	8.42 ps	10.2 ps	14 ps	16.9 ps
TDR step response resolution in free space ⁴ ($\epsilon_r = 1$) (min)	nom.	1.3 mm	1.5 mm	2.1 mm	2.5 mm
TDR impulse width (min) ³	spec.	11.4 ps	13.8 ps	18.9 ps	22.8 ps
TDR deskew range (max) ⁵ (test cable length)	typ.	50 ns	50 ns	50 ns	50 ns
DUT length (max) ⁶	spec.	1.25 μ s	1.25 μ s	1.25 μ s	1.25 μ s
TDR stimulus repetition rate (max)	spec.	52.9 MHz	43.9 MHz	31.9 MHz	26.4 MHz
RMS noise level ⁷	typ.	120 μ Vrms	80 μ Vrms	80 μ Vrms	80 μ Vrms
Eye diagram data rate (max) ⁸	spec.	42.4 Gb/s	35.2 Gb/s	25.6 Gb/s	21.2 Gb/s

1. The time domain function of the S95011B is similar to the time domain reflectometry (TDR) measurement on a TDR oscilloscope in that it displays the response in the time domain. In the TDR oscilloscope measurement, a pulse or step stimulus is input to the DUT and the change of the reflected wave over time is measured. In the S95011B TDR measurement, a sine wave stimulus is input to the DUT and the change of the reflected wave over frequency is measured. Then, the frequency domain response is transformed to the time domain using the Inverse Fourier Transform.
2. The TDR step amplitude setting does not vary the actual stimulus level input to the device but is used when calculating the Inverse Fourier Transform.
3. Minimum values may be limited by the DUT length setting.
4. To convert from rise time to response resolution, multiply the rise time by c , the speed of light in free space. To calculate the actual physical length, multiply this value in free space by v_f , the relative velocity of propagation in the transmission medium. (Most cables have a relative velocity of 0.66 for a polyethylene dielectric or 0.7 for a PTFE dielectric.)
5. Using high quality cables to connect the DUT is recommended in order to minimize measurement degradation. The cables should have low loss, low reflections, and minimum performance variation when flexed.
6. Maximum DUT length is the sum of the DUT and test cable lengths.
7. RMS noise level with 50 Ω DUT and default setup.
8. Maximum values may be limited by the DUT length setting.

Multi-module Measurements with S9551B Software

When the S9551B software is installed, the M980xA PXIe VNA can be configured into a multiport network analyzer with multiple PXI VNA modules. Adding a second module to the PXI chassis provides additional test ports allowing the configuration of a multiport VNA. This configuration provides a full featured multiport vector network analyzer with full crossbar S-parameter measurement capability.

Multiport configurations using up to 17 M980xA modules (ex. 34-ports with 2-port modules) or maximum 66 test ports (11x 6-port M980xA modules) have been evaluated. M983xA configurable PXI VNA modules can be added to a multiport configuration as well. Multiport configurations using two M983xA modules and ten M980xA modules in a single PXI chassis (ex. maximum 24-port, 44 GHz configuration) have been evaluated.

For multi-module operation, all single-module specifications apply except trace noise, test port noise floor, system dynamic range, Displayed Average Noise Level (DANL) and SA detector accuracy. The other performance of multi-module configurations will meet the single-module specifications.

The guidance provided here is given as general reference based on Keysight’s evaluation of multiport PXIe VNA configurations. Not all multiport setups using multiple PXIe VNAs are tested as a multiport instrument in the factory. Interconnect cables included in the Y1730A must be used for connection among multiple M980xA and M983xA modules. For more detail of multi-module configurations, refer to “M980xA and M983xA PXIe VNA Multi-module Installation Guide” at www.keysight.com/find/m980xa-mm.

Table 43. Multi-module performance

- A check mark, ✓, indicates the performance parameter is the same as the corresponding single-module performance.
- An empty diamond, ◇, indicates that the performance parameter may be degraded as the number of modules increases.

Description	Setups with 2 to 17 modules
System dynamic range	◇ (see Table 44)
Frequency accuracy	✓
Uncorrected directivity	✓
Uncorrected load match	✓
Uncorrected source match	✓
Maximum output port power	✓
Power level accuracy	✓
Power level linearity	✓
Noise floor	◇ (see Table 45)
Receiver compression	✓
Trace noise	◇ (see Table 46 and 47)
Dynamic accuracy	✓
Crosstalk	✓

Table 44. System dynamic range of multi-module configuration (dB) ¹

M9800A, M9801A, M9802A, M9803A, M9804A

Description	2 to 4 M980xA modules		5 to 17 M980xA modules	
	Char.	Typical	Char.	Typical
9 kHz to 100 kHz	101	111	94	110
100 kHz to 300 kHz	117	126	114	126
300 kHz to 1 MHz	125	136	114	126
1 MHz to 10 MHz	130	141	127	139
10 MHz to 50 MHz ²	137	147	134	147
50 MHz to 3 GHz	140	150	137	150
3 GHz to 4.5 GHz	140	149	137	149
4.5 GHz to 5 GHz	140	149	135	147
5 GHz to 6.5 GHz	140	148	135	147
6.5 GHz to 9 GHz	136	146	133	146
9 GHz to 14 GHz	133	142	125	139
14 GHz to 16 GHz	127	140	122	137
16 GHz to 20 GHz	124	137	119	134

M9805A, M9806A, M9807A, M9808A

Description	2 to 12 M980xA modules		13 to 17 M980xA modules	
	Char.	Typical	Char.	Typical
100 kHz to 300 kHz	95	106	95	106
300 kHz to 500 kHz	104	120	104	120
500 kHz to 1 MHz	117	130	117	130
1 MHz to 10 MHz	125	138	125	138
10 MHz to 50 MHz ²	137	147	137	147
50 MHz to 6.5 GHz	140	150	140	150
6.5 GHz to 8 GHz	138	150	138	150
8 GHz to 9 GHz	138	147	138	147
9 GHz to 16 GHz	137	147	137	147
16 GHz to 17 GHz	137	143	137	143
17 GHz to 20 GHz	132	143	132	143
20 GHz to 24 GHz	130	143	130	143
24 GHz to 25 GHz	130	141	130	141
25 GHz to 26 GHz	127	141	127	141
26 GHz to 30 GHz	127	137	127	137
30 GHz to 35 GHz	122	137	122	137
35 GHz to 40 GHz	122	134	122	134
40 GHz to 45 GHz	122	132	122	132
45 GHz to 50 GHz	100	115	100	115
50 GHz to 53 GHz	72	101	72	101

1. System dynamic range = source maximum output power minus receiver noise floor at 10 Hz IF bandwidth. Does not include crosstalk effects.

2. It may typically be degraded at 25 MHz.

Table 45. Test port noise floor of multi-module configuration (dBm) ¹

M9800A, M9801A, M9802A, M9803A, M9804A

Description	2 to 4 M980xA modules		5 to 17 M980xA modules	
	Char.	Typical	Char.	Typical
9 kHz to 100 kHz	-101	-109	-94	-108
100 kHz to 300 kHz	-112	-119	-109	-119
300 kHz to 1 MHz	-120	-127	-109	-119
1 MHz to 10 MHz	-125	-132	-122	-132
10 MHz to 50 MHz ²	-127	-134	-124	-134
50 MHz to 3 GHz	-130	-137	-127	-137
3 GHz to 4.5 GHz	-130	-136	-127	-136
4.5 GHz to 6.5 GHz	-130	-135	-125	-135
6.5 GHz to 9 GHz	-127	-134	-124	-134
9 GHz to 14 GHz	-126	-132	-118	-129
14 GHz to 16 GHz	-120	-130	-115	-127
16 GHz to 20 GHz	-120	-130	-115	-127

M9805A, M9806A, M9807A, M9808A

Description	2 to 12 M980xA modules		13 to 17 M980xA modules	
	Char.	Typical	Char.	Typical
100 kHz to 300 kHz	-97	-105	-97	-105
300 kHz to 500 kHz	-97	-110	-97	-110
500 kHz to 1 MHz	-110	-120	-110	-120
1 MHz to 10 MHz	-115	-124	-115	-124
10 MHz to 50 MHz ²	-127	-133	-127	-133
50 MHz to 200 MHz	-130	-133	-130	-133
200 MHz to 3 GHz	-130	-137	-130	-137
3 GHz to 6.5 GHz	-130	-135	-130	-135
6.5 GHz to 9 GHz	-128	-134	-128	-134
9 GHz to 17 GHz	-127	-133	-127	-133
17 GHz to 25 GHz	-125	-131	-125	-131
25 GHz to 30 GHz	-122	-129	-122	-129
30 GHz to 45 GHz	-120	-127	-120	-127
45 GHz to 50 GHz	-105	-115	-105	-115
50 GHz to 53 GHz	-95	-113	-95	-113

1. Noise floor in a 10 Hz IF Bandwidth. Measured with 1 kHz IF bandwidth for 9 kHz to < 100 kHz, and 30 kHz IF bandwidth for 100 kHz to 53 GHz. Test port terminated.
 2. It may typically be degraded at 25 MHz.

Table 46. Trace noise magnitude of multi-module configurations (dB rms) ¹

M9800A, M9801A, M9802A, M9803A, M9804A

Description	2 to 4 M980xA modules		5 to 17 M980xA modules	
	Char.	Typical	Char.	Typical
9 kHz to 30 kHz	0.005	0.0025	0.01	0.0025
30 kHz to 100 kHz	0.003	0.001	0.006	0.001
100 kHz to 10 MHz	0.0025	0.0005	0.003	0.0005
10 MHz to 6 GHz ²	0.002	0.0005	0.003	0.0005
6 GHz to 10 GHz	0.002	0.0006	0.004	0.0006
10 GHz to 13.5 GHz	0.003	0.001	0.006	0.001
13.5 GHz to 20 GHz	0.004	0.001	0.007	0.001

M9805A, M9806A, M9807A, M9808A

Description	2 to 12 M980xA modules		13 to 17 M980xA modules	
	Char.	Typical	Char.	Typical
100 kHz to 300 kHz	0.005	0.002	0.005	0.002
300 kHz to 1 MHz	0.003	0.001	0.003	0.001
1 MHz to 4.5 GHz ²	0.0015	0.0005	0.0015	0.0005
4.5 GHz to 10 GHz	0.0015	0.0007	0.0015	0.0007
10 GHz to 17 GHz	0.002	0.001	0.002	0.001
17 GHz to 30 GHz	0.003	0.0013	0.003	0.0013
30 GHz to 45 GHz	0.006	0.0022	0.006	0.0022
45 GHz to 50 GHz	0.018	0.006	0.018	0.006

1. Reflection trace noise in a 1 kHz IF bandwidth for < 10 MHz, 10 kHz IF bandwidth for ≥ 10 MHz. At maximum specified power.
2. It may typically be degraded at particular frequencies such as 25 MHz, 54 MHz, 58.5 MHz, 108 MHz, 120 MHz or 132 MHz, 143 MHz, or 156 MHz.

Table 47 trace noise phase of multi-module configurations (degree rms) ¹

M9800A, M9801A, M9802A, M9803A, M9804A

Description	2 to 4 M980xA modules		5 to 17 M980xA modules	
	Char.	Typical	Char.	Typical
9 kHz to 30 kHz	0.07	0.025	0.07	0.025
30 kHz to 100 kHz	0.05	0.017	0.05	0.017
100 kHz to 300 kHz	0.035	0.006	0.035	0.006
300 kHz to 10 MHz	0.015	0.003	0.02	0.006
10 MHz to 6 GHz ²	0.015	0.003	0.04	0.006
6 GHz to 10 GHz	0.025	0.006	0.06	0.012
10 GHz to 13.5 GHz	0.036	0.006	0.09	0.012
13.5 GHz to 20 GHz	0.045	0.01	0.12	0.02

M9805A, M9806A, M9807A, M9808A

Description	2 to 12 M980xA modules		13 to 17 M980xA modules	
	Char.	Typical	Char.	Typical
100 kHz to 300 kHz	0.07	0.015	0.07	0.015
300 kHz to 1 MHz	0.03	0.01	0.03	0.01
1 MHz to 6 GHz ²	0.02	0.003	0.02	0.003
6 GHz to 10 GHz	0.02	0.004	0.02	0.004
10 GHz to 17 GHz	0.02	0.006	0.02	0.006
17 GHz to 30 GHz	0.02	0.01	0.02	0.01
30 GHz to 45 GHz	0.04	0.018	0.04	0.018
45 GHz to 50 GHz	0.18	0.03	0.18	0.03

1. Reflection trace noise in a 1 kHz IF bandwidth for < 10 MHz, 10 kHz IF bandwidth for ≥ 10 MHz. At maximum specified power.
2. It may typically be degraded at particular frequencies such as 25 MHz, 54 MHz, 58.5 MHz, 108 MHz, 120 MHz or 132 MHz, 143 MHz, or 156 MHz.

General Information

Table 48. Miscellaneous information

Description	Specification
System IF bandwidth range	1 Hz to 15 MHz
Number of points	1 to 100,003

Table 49. System requirements

PC system requirements

Operating systems	Windows 10 and Windows 11 (64-bit)
Recommended CPU	Intel Core i7 10th Generation or later recommended
Available memory	16 GB recommended, 4 GB minimum
Available disk space	4 GB minimum
Display resolution	1024 x 768 minimum

Instrument drivers





Keysight IO libraries	Keysight IO Libraries Suite 2022 Update 1 (18.2.28014.7) or later (for Windows 10) Keysight IO Libraries Suite 2023 Update 1 (18.3.29324.3) or later (for Windows 11)
-----------------------	--

Table 50. Environmental and physical specifications

Description		
Descriptions	<p>Samples of this product have been type tested in accordance with the Keysight Environmental Test Manual and verified to be robust against the environmental stresses of Storage, Transportation and End-use; those stresses include, but are not limited to, temperature, humidity, shock, vibration, altitude, and power line conditions.</p> <p>Test Methods are aligned with IEC 60068-2 and levels are similar to MIL-PRF-28800F Class 3.</p>	
Temperature	Operating	0 to 50 °C ambient 10 to 70 °C module temperature
	Non-operating	-40 to 70 °C
Humidity	Operating	Type tested at 20 to 80 %, wet bulb temperature < 29 °C (non-condensing)
	Non-operating	Type tested at 20 to 90 %, wet bulb temperature < 40 °C (non-condensing)
Altitude	Operating	Up to 2,000 meters (6,561 feet)
	Non-operating	Up to 4,572 meters (15,000 feet)
Vibration	Operating	0.3 G maximum, 5 Hz to 500 Hz
	Non-operating	0.75 G maximum, 5 Hz to 500 Hz
Instrument protection	IP 30 IEC/EN 60529	
Warm-up time	60 minutes	

Table 51. Regulatory and safety compliance

EMC ¹

Complies with the essential requirements of the European EMC Directive as well as current editions of the following standards (dates and editions are cited in the Declaration of Conformity).	
	<p>The CE mark is a registered trademark of the European Community (if accompanied by a year, it is the year when the design was proven). This product complies with all relevant directives.</p> <ul style="list-style-type: none"> • IEC 61326-1 • CISPR 11 Group 1, Class A
	<p>UK conformity mark is a UK government owned mark. When affixed to the product is declaring all applicable Directives and Regulations have been met in full.</p>
<p>CAN ICES/NMB-001(A)</p>	<p>This ISM device complies with Canadian ICES-001. Cet appareil ISM est conforme a la norme NMB du Canada.</p>
	<p>The RCM mark is a registered trademark of the Australian Communications and Media Authority.</p> <ul style="list-style-type: none"> • AS/NZS CISPR 11
	<p>South Korean Certification (KC) mark; includes the marking's identifier code: R-R-Kst-xxxxxx</p> <p>South Korean Class A EMC declaration: Information to the user: This equipment has been conformity assessed for use in business environments. In a residential environment this equipment may cause radio interference.</p>

※ This EMC statement applies to the equipment only for use in business environment.

사 용 자 안 내 문

이 기기는 업무용 환경에서 사용할 목적으로 적합성평가를 받은 기기로서 가정용 환경에서 사용하는 경우 전파간섭의 우려가 있습니다.

※ 사용자 안내문은 “업무용 방송통신기자재”에만 적용한다.

Instrument calibration cycle	1 year
------------------------------	--------

1. To find a current Declaration of Conformity for a specific Keysight product, go to: <http://www.keysight.com/go/conformity>

Table 52. Physical size and weight

M9800A, M9801A, M9802A, M9803A, M9804A

Description	2-port (Option 200)	4-/6-port (Option 400/600)	Note
Width	22 mm (0.87 in.)	42 mm (1.65 in.)	Including the backplane connector alignment tabs, and front panel ground clip in free state
Height	130 mm (5.12 in.)	130 mm (5.12 in.)	Including the ejector hook
Depth	210 mm (8.27 in.)	210 mm (8.27 in.)	From tip of ejector to tip of backplane connector
Weight	540 g (1.2 lbs.)	4-port: 1,010 g (2.2 lbs.), 6-port: 1,170 g (2.6 lbs.)	

M9805A, M9806A, M9807A, M9808A

Description	2-port (Option 200)	4-/6-port (Option 400/600)	Note
Width	22 mm (0.87 in.)	--	Including the backplane connector alignment tabs, and front panel ground clip in free state
Height	130 mm (5.12 in.)	--	Including the ejector hook
Depth	210 mm (8.27 in.)	--	From tip of ejector to tip of backplane connector
Weight	685 g (1.5 lbs.)	--	

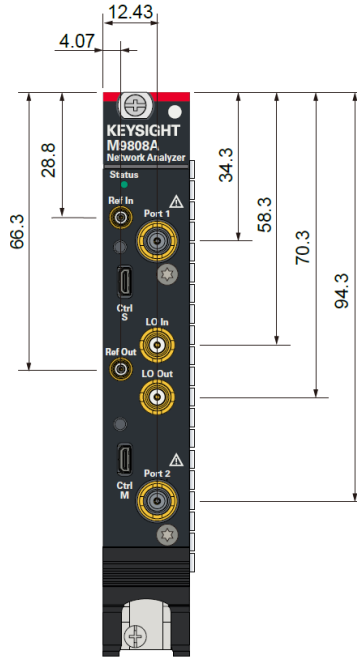

Dimensions (front view, M9800A to M9808A with option 200, in millimeters)

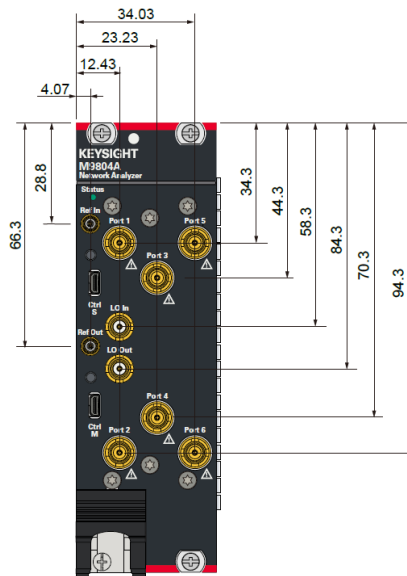

Dimensions (front view, M9800A to M9804A with option 600, in millimeters)

Table 53. Electrical power

M9800A, M9801A, M9802A, M9803A, M9804A

Description

2-port (Option 200)				
Total power dissipation	37.8 W (maximum)			
Supply voltage	+3.3 V	+5 V	+12 V	-12 V
Nominal current	3.1 A	0 A	2.3 A	0 A
4-port (Option 400)				
Total power dissipation	59.3 W (maximum)			
Supply voltage	+3.3 V	+5 V	+12 V	-12 V
Nominal current	4.9 A	0 A	3.6 A	0 A
6-port (Option 600)				
Total power dissipation	79.7 W (maximum)			
Supply voltage	+3.3 V	+5 V	+12 V	-12 V
Nominal current	6.7 A	0 A	4.8 A	0 A

M9805A, M9806A, M9807A, M9808A

Description

2-port (Option 200)				
Total power dissipation	36.8 W (maximum)			
Supply voltage	+3.3 V	+5 V	+12 V	-12 V
Nominal current	2.9 A	0 A	2.3 A	0 A

Table 54. Front Panel Information

Description

Test port	
Connector type	3.5 mm female (M9800A, M9801A, M9802A, M9803A, M9804A, M9805A) 2.4 mm female (M9806A, M9807A) 1.85 mm female (M9808A)
Center pin recession	0.003 inch (characteristic)
Impedance	50 Ω (nominal)
External reference input	
Connector type	MCX
Input amplitude range	-3 to +10 dBm
Input frequency ¹	10 MHz \pm 10 ppm
Impedance	50 Ω (nominal)
External reference output	
Connector type	MCX
Output amplitude range	0 to \pm 3 dBm

Description

Output frequency	10 MHz \pm 7 ppm
Impedance	50 Ω (nominal)

1. Input frequency reference of 100 MHz is also acceptable with some limitations. See [PXI VNA webhelp](#) for more details.

Measurement Throughput

Table 55. Cycle time for measurement completion (milliseconds) ¹ – typical

M9800A, M9801A, M9802A, M9803A, M9804A

Description	Sweep mode: Auto			Sweep mode: Stepped		
800 MHz – 1 GHz frequency span, 1 MHz IF bandwidth						
Number of points	201	401	1601	201	401	1601
Uncorrected	1.5	1.6	3.7	1.6	2.1	4.5
2-port calibration	1.9	2.7	6.9	2.6	3.7	8.5
4-port calibration	3.4	4.9	13.8	4.7	7.0	16.7
6-port calibration	6.6	9.8	26.1	7.7	11.6	27.3
24-port calibration ²	78.1	129.2	339.8	84.0	130.5	346.0
9 GHz – 10 GHz frequency span, 1 MHz IF bandwidth						
Number of points	201	401	1601	201	401	1601
Uncorrected	1.4	1.6	3.9	1.8	2.5	6.2
2-port calibration	1.9	2.6	6.9	3.0	4.6	12.0
4-port calibration	3.5	4.9	13.7	5.8	8.9	23.8
6-port calibration	6.7	9.9	26.3	8.9	14.4	36.9
24-port calibration ²	83.9	129.8	342.9	78.5	133.9	341.8
10 MHz – 9 GHz frequency span, 1 MHz IF bandwidth						
Number of points	201	401	1601	201	401	1601
Uncorrected	3.3	4.3	7.4	3.3	4.8	11.1
2-port calibration	5.9	8.1	14.3	5.9	9.0	21.9
4-port calibration	11.4	15.8	28.4	11.4	17.6	43.3
6-port calibration	17.5	24.9	44.6	17.6	27.5	65.8
24-port calibration ²	101.8	157.6	347.4	102.3	164.7	341.8
10 MHz – 20 GHz frequency span, 1 MHz IF bandwidth						
Number of points	201	401	1601	201	401	1601
Uncorrected	3.9	5.6	8.0	3.9	5.6	14.2
2-port calibration	7.2	10.6	15.5	7.2	10.5	27.9
4-port calibration	14.0	20.7	30.6	14.0	20.6	55.4
6-port calibration	21.5	32.2	47.4	21.5	32.2	84.4
24-port calibration ²	116.3	186.2	355.0	116.3	183.2	408.6

M9805A, M9806A, M9807A, M9808A

Description	Sweep mode: Auto			Sweep mode: Stepped		
	201	401	1601	201	401	1601
9 GHz – 10 GHz frequency span, 1 MHz IF bandwidth						
Number of points	201	401	1601	201	401	1601
Uncorrected	1.5	2.0	5.6	1.8	2.5	6.2
2-port calibration	2.4	3.5	10.7	3.0	4.5	12.0
4-port calibration ³	5.0	7.0	21.4	5.7	8.8	23.8
24-port calibration ⁴	90.3	149.6	362.5	80.7	123.1	301.6
10 MHz – 26.5 GHz frequency span, 1 MHz IF bandwidth						
Number of points	201	401	1601	201	401	1601
Uncorrected	4.5	6.2	9.4	4.5	6.2	15.5
2-port calibration	8.3	11.8	18.3	8.4	11.8	30.5
4-port calibration ³	16.3	23.4	36.9	16.3	23.4	61.0
24-port calibration ⁴	132.5	207.4	359.5	132.3	204.5	467.6
10 MHz – 40 GHz frequency span, 1 MHz IF bandwidth						
Number of points	201	401	1601	201	401	1601
Uncorrected	4.9	6.8	11.6	4.9	6.8	16.7
2-port calibration	9.0	13.1	22.6	9.0	13.0	32.9
4-port calibration ³	17.9	26.0	45.4	17.9	26.0	65.5
24-port calibration ⁴	141.3	222.6	367.6	141.2	217.3	489.4
10 MHz – 53 GHz frequency span, 1 MHz IF bandwidth						
Number of points	201	401	1601	201	401	1601
Uncorrected	5.3	7.3	14.3	5.3	7.3	17.8
2-port calibration	9.8	13.9	28.0	9.8	13.9	35.1
4-port calibration ³	19.4	27.7	56.1	19.4	27.9	70.0
24-port calibration ⁴	148.2	228.8	435.0	147.2	226.5	522.0

1. Analyzer display turned off with DISPlay:VISible OFF. Measured using a Keysight M9019A PXIe chassis, and an M9037A embedded controller with Intel Core i7-4700EQ 2.40 GHz CPU and 16 GB RAM running Windows 10 (64-bit), with firmware revision A.14.10.08. Data for one trace (S11) measurement. Uncorrected measurements are for one sweep direction.
2. With four 6-port M980xA modules.
3. With two 2-port M980xA modules.
4. With twelve 2-port M980xA modules.

Table 56. Software

Description	Typical
Keysight IO library	The IO library suite offers a single entry point for connection to the most common instruments including AXIe, PXI, GPIB, USB, Ethernet/LAN, RS-232, and VXI test instrument from Keysight and other vendors. It automatically discovers interfaces, chassis, and instruments. The graphical user interface allows you to search for, verify, and update IVI instrument and soft front panel drivers for modular and traditional instruments. The IO suite safely installs in side-by-side mode with NI I/O software. Free software download at www.keysight.com/find/iosuite
Keysight soft front panel	The PXI module includes a soft front panel (SFP), a software based graphical user interface (GUI) which enables the instrument's capabilities from your PC.
Command Expert	Assists in finding the right instrument commands and setting correct parameters. A simple interface includes documentation, examples, syntax checking, command execution, and debug tools to build sequences for integration in Excel, MATLAB, LabVIEW, VEE, and System VUE. Free software download at www.keysight.com/find/commandexpert
Example programs	Setting up a measurement Guided calibration Data acquisition Data transfer
Example programming languages	C, C++, C#, VB, LabVIEW

Test Set Block Diagrams

Legend

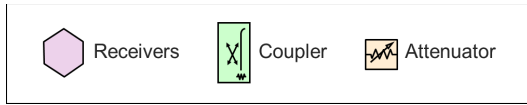

M980xA Series Option 200 (2-port base model)

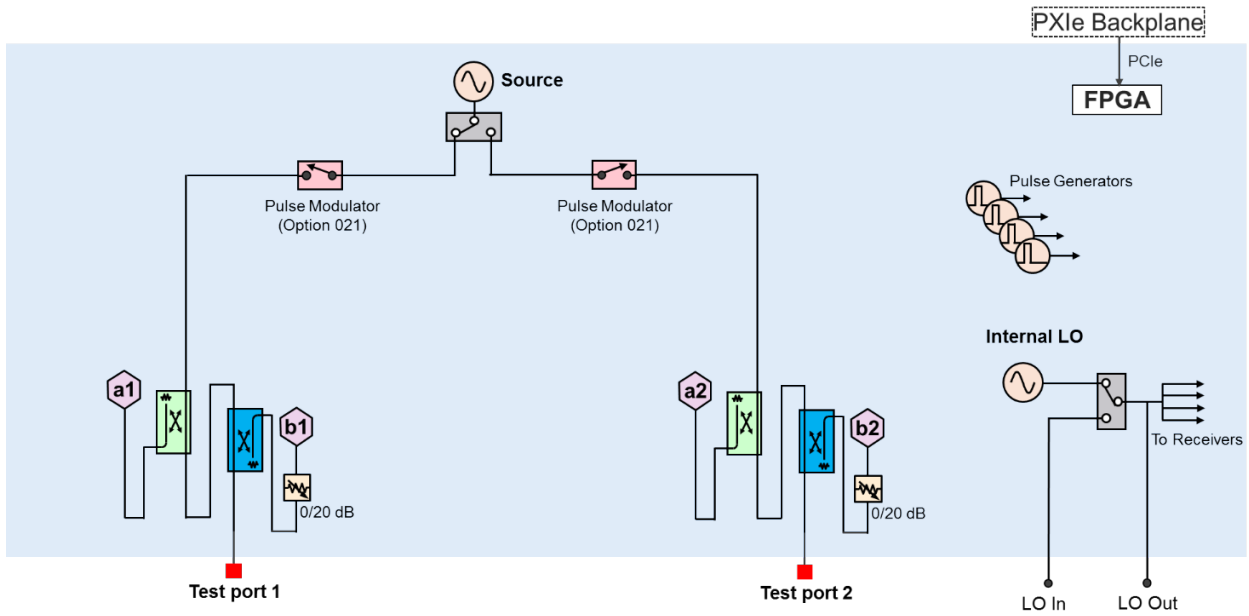

M980xA Series Option 400 (4-port base model)

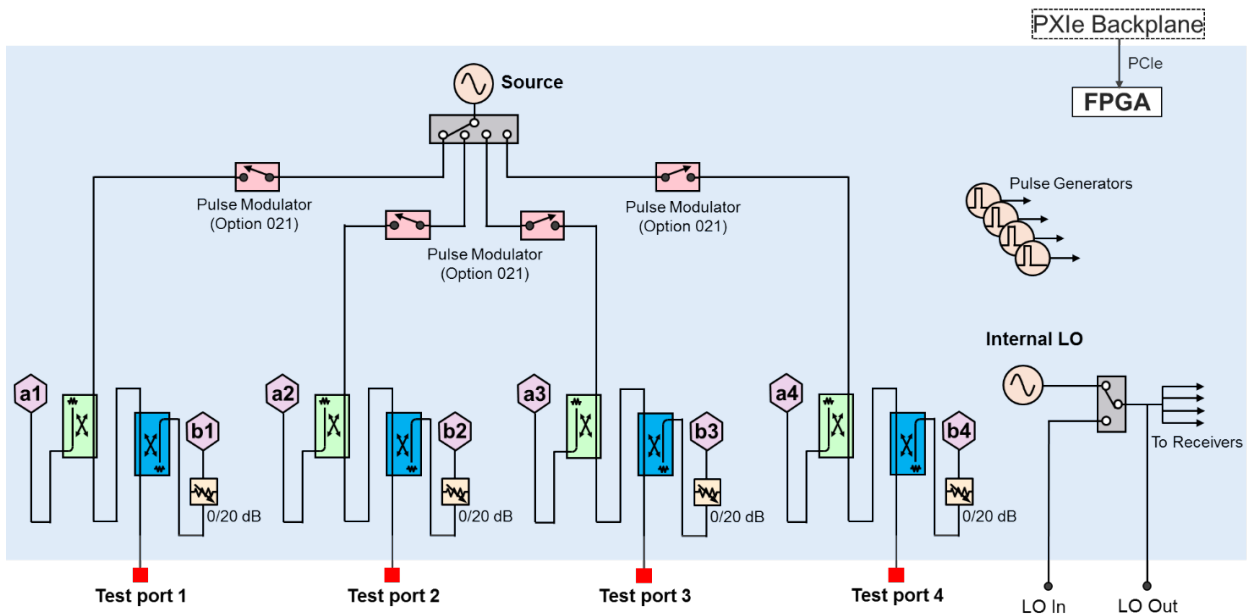

M980xA Series Option 600 (6-port base model)

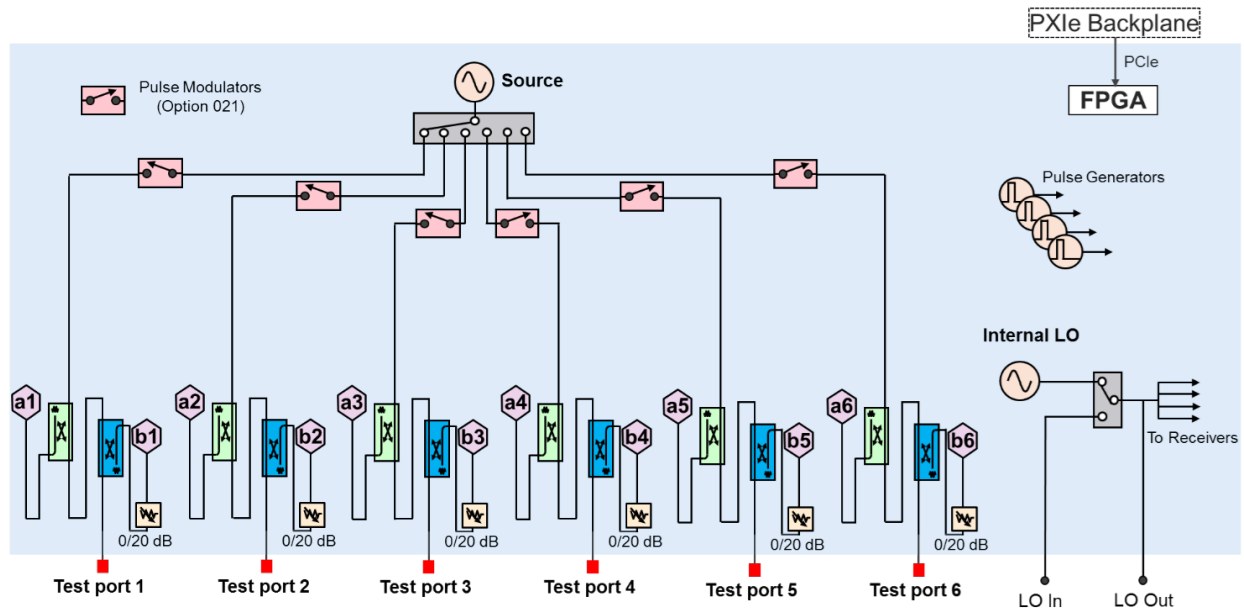

Literature Information

- M983x/M980xA PXIe Vector Network Analyzer – Configuration Guide, [5992-3597EN](#)
- Keysight PXI Vector Network Analyzer – Product Fact Sheet, [3122-2110.EN](#)
- Keysight Network Analyzer – Selection Guide, [5989-7603EN](#)
- Electronic Calibration (ECal) Modules for Network Analyzer – Technical Overview, [5963-3743E](#)

Web Resources

- Keysight Vector Network Analyzer Page - www.keysight.com/find/na
- Keysight PXI Vector Network Analyzer Page - www.keysight.com/find/pxivna
- Keysight Vector Network Analyzer Software Page - www.keysight.com/find/vnasoftware
- Keysight Electronic Calibration (ECal) Module Page - www.keysight.com/find/ecal

Confidently Covered by Keysight Services

Prevent delays caused by technical questions, or system downtime due to instrument maintenance and repairs with Keysight Services. Keysight Services are here to support your test needs with expert technical support, instrument repair and calibration, software support, training, alternative acquisition program options, and more.

A KeysightCare agreement provides dedicated, proactive support through a single point of contact for instruments, software, and solutions. KeysightCare covers an extensive group of instruments, application software, and solutions and ensures optimal uptime, faster response, faster access to experts, and faster resolution.

Keysight Services

Offering	Benefits
KeysightCare 	KeysightCare provides elevated support for Keysight instruments and software, with access to technical support experts that respond within a specified time and ensure committed repair and calibration turnaround times (TAT). KeysightCare offers multiple service agreement tiers, including KeysightCare Assured, Enhanced, and Application Software Support. See the KeysightCare data sheet for details.
KeysightCare Assured	KeysightCare Assured goes beyond basic warranty with repair services that include committed TAT and unlimited access to technical experts.
KeysightCare Enhanced	KeysightCare Enhanced includes all the benefits of KeysightCare Assured plus Keysight's accurate and reliable calibration services, accelerated, and committed TAT, and technical response.
Keysight Support Portal & Knowledge Center	All KeysightCare tiers include access to the Keysight Support Portal where you can manage support and service resources related to your assets such as service requests, and status, or browse the Knowledge Center.
Education Services	Build confidence and gain new skills to make accurate measurements, with flexible Education Services developed by Keysight experts. Including Start-up Assistance.
Alternative acquisition options	
KeysightAccess	Reduce budget challenges with a subscription service enabling you to get the instruments, software, and technical support you want for your test needs.

Recommended services

Maximize your test system up-time by securing technical support, repair, and calibration services with committed response and turnaround times. 1-year KeysightCare Assured is included in every new instrument purchase. Obtain multi-year KeysightCare upfront to eliminate the need for lengthy and tedious paperwork and yearly requests for maintenance budget. Plus, you benefit from secured service for 2, 3, or 5 years.

Service	Function
KeysightCare Enhanced*	Includes tech support, warranty and calibration
R-55B-001-1	KeysightCare Enhanced – Upgrade 1 year
R-55B-001-2	KeysightCare Enhanced – Extend to 2 years
R-55B-001-3	KeysightCare Enhanced – Extend to 3 years (Recommended)
R-55B-001-5	KeysightCare Enhanced – Extend to 5 years (Recommended)
KeysightCare Assured	Includes tech support and warranty
R-55A-001-2	KeysightCare Assured – Extend to 2 years
R-55A-001-3	KeysightCare Assured – Extend to 3 years
R-55A-001-5	KeysightCare Assured – Extend to 5 years
Start-Up Assistance	
PS-S10	Included – instrument fundamentals and operations starter
PS-S20	Optional, technology & measurement science standard learning

* Available in select countries. For details, please view the [datasheet](#). R-55B-001-2/3/5 must be ordered with R-55B-001-1.

Keysight enables innovators to push the boundaries of engineering by quickly solving design, emulation, and test challenges to create the best product experiences. Start your innovation journey at www.keysight.com.



This information is subject to change without notice. © Keysight Technologies, 2019 - 2024, Published in USA, December 6, 2024, 5992-3596EN