

# Industrial Intrinsically Safe Tablet PC/PAD

## Quick Guide



**XPad\_07**

4G Full Frequency

### Safety Instructions

Ordinary PADs are forbidden in explosion hazardous areas where explosions may happen. Such areas include: fuel areas (such as below deck of a ship, fuel or chemical products transportation and storage facilities), locations where the air containing chemicals or particles (such as granule, dust or metal powders) such as gas stations, oil storage tanks. Developed by Beijing Dorland System Control Technology Co., LTD., the industrial intrinsically safe tablet PC/PAD XPad\_07 has been tested and certified by explosion-proof certification body of China and can meet the requirement of GB3836.1-2010 "explosive atmospheres - Part 1: Equipment-General requirements" and GB3836.4-2010 "explosive atmospheres - Part 4: equipment protection by intrinsic safety 'I' ". It is suitable for Zone 1 and Zone 2 explosion hazardous areas.

### Basic parameters

Explosion-proof grade: Ex ib IIC T4 Gb / Ex ibD 21 T130°C  
 Certification No.: CCRI 18.2218  
 Protection grade: IP67

### Safety Warning

Safety performance of industrial intrinsically safe tablet PC/PAD XPad\_07 can be guaranteed only in strict accordance with the instructions in this section. Please read the instruction carefully before using. If you have any questions, please contact the manufacturer immediately.

### Safety Rules

Safety performance of industrial intrinsically safe tablet PC/PAD XPad\_07 is under the premise that the users obey the following rules.

- The battery for XPad\_07 is made by the manufacturer specializing in the production of batteries. Only the original battery meets the intrinsically safety requirements. Any other non-original batteries will result in the loss of explosion-proof performance of the PAD. Please make sure to use the original battery. For battery replacement, please contact Beijing Dorland System Control Tech Co.,LTD. The battery for XPad\_07 is Ex Battery 020 8000mAh explosion-proof polymer battery.
- Please use the original charger when recharging battery, and make sure in the safe areas. The maximum charge voltage is 4.2V.
- Don't replace battery for XPad\_07 in explosion hazardous areas.
- XPad\_07 cannot be used in explosion danger zone 0.
- Do not use headset, data cable plug devices in the explosion hazardous areas.
- Do not use the flash function in explosion hazardous areas.
- Do not use the vibration function of the PAD in explosion hazard areas.
- Please keep away from high-temperature region when using XPad\_07.

### Failure and damage processing

If safety performance of industrial intrinsically safe tablet PC/PAD XPad\_07 has lost, please stop using in explosion hazardous areas. Please ship the failure PADs back to the manufacturer for testing. Situations that may cause failure of XPad\_07 explosion-proof performance include the following ones:  
 The PAD shell is damaged;  
 Storage place does not meet the storage conditions;  
 Damaged during transport;  
 Explosion-Proof mark is unrecognized;  
 Other functions fail.

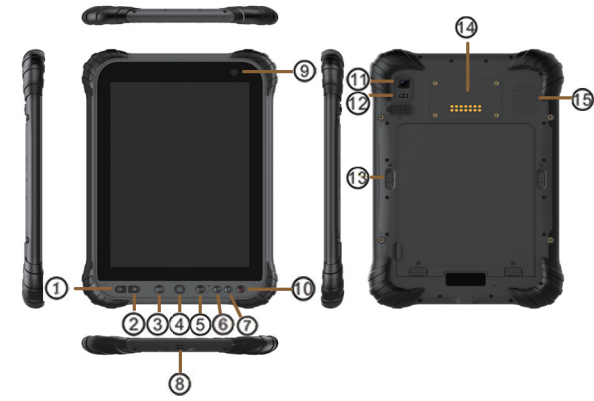

- |                      |                  |                  |
|----------------------|------------------|------------------|
| 1. Volume-;          | 2. Volume+;      | 3. Small window; |
| 4. Menu Key;         | 5. Back key;     | 6. hot key1;     |
| 7. hot key2;         | 8. USB plug;     | 9. Front camera; |
| 10. Power key;       | 11. Main camera; | 12. Flashlight;  |
| 13. Back cover lock; | 14. Serial port; | 15. Speaker      |



### Battery Charging

The specific PAD has a built-in battery. Please make sure to use original charger and USB cable when charging it. Warning tone will prompt that when battery runs low. If power further decreases, the PAD will prompt again and power off automatically.

Notice: Heavy stuff placed on the PAD may damage the screen and the product. Product images only for reference purpose, so please see the subject produce.

Notice: Please power off the phone and cut off all power connected to the phone if you are to install or remove SIM card.

### Install SIM / SD card



As shown, push up the arrow position Lock the buckle and open the battery back cover.



As shown, Open the battery back cover and remove the battery in the figure, and install the SIM card and SD card in the direction of the arrow.

### Waterproof Strategies

Tail plug waterproof: install tail plugs and check again to make sure that it is tight, so as to be waterproof perfectly; Preparatory work before entering water:

- Make sure to install battery cover tightly before entering water.
- Make sure that there are no hair, grain of sand or other things influencing the closeness of the cover before installing the battery cover.

Maintenance methods after getting out of water

- You should dry the phone completely using a towel or a paper towel before opening it;
- When you open cover, make sure the cover downwards to prevent water in the tank flowing into the inner positions;
- Please spin-dry speaker and microphone emphatically, and get them air-dry after the whole phone gets out of water. Drying them with hair dryer is prohibitive.

Prohibition:

- Do not use in spa or hot water. The waterproof rubber ring can not stand high temperatures, and leads to water inflow.
- Remember! Do not open the battery cover before the phone is completely dry!
- Do not clean with detergents and other chemicals. Water is OK.



## Create shortcuts and widgets

Click the home screen and then Pop-up list of applications. Hold and click the application icon which you want to add to shortcut. Drag the application icon to the area you want to place, then release it. Adding widgets is the same as adding shortcut,or you can also enter the widget menu to add widgets. Shown as the following figures:



1

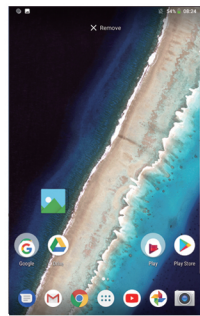

2

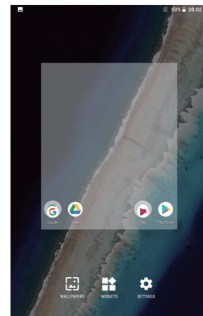

3

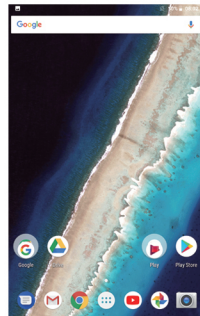

4

7

## Delete shortcuts and widgets

Tap and hold the application, then drag it towards the icon **X Remove** on the upper screen. When the application turns red, please release it, and the selected application will be deleted.

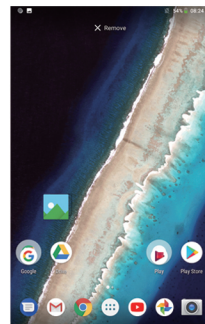

8

## Set wallpaper

Tap and hold the home screen then click <WALLPAPERS> to enter wallpaper gallery, you can choose image/live wallpaper/video wallpaper as your wallpaper. Shown as the following figures:

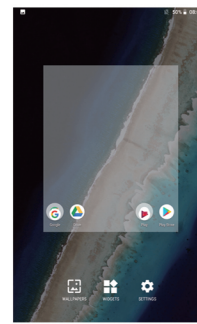

9

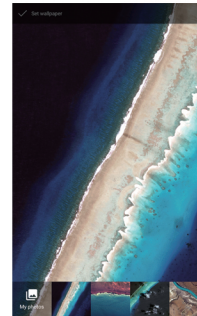

10

## Notification Bar

Slide the screen downwards in unlock status to open the notification bar. You can find unread notifications here. Click the icon on the right upper corner of the interface, a variety of settings interface will be shown.

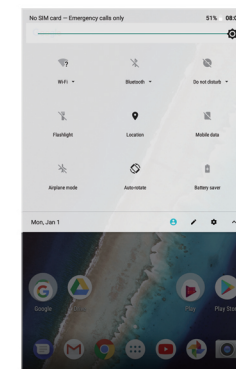

## Recently used applications

Tap the menu key, the screen will display an interface, which shows your recently used applications. Click the icon to open the application. Slide the icon left to close the application.

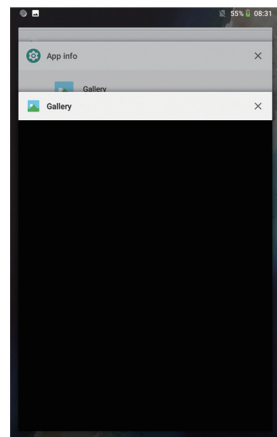

11

## Precautions

- Keep the phone far away from magnetic equipment, for its radiation may erase the information stored on magnetic devices.
  - Do not place this phone, battery and charger in containers with strong magnetic field, such as induction cooker and microwave oven, which may cause circuit failure, fire, or explosion.
  - Do not place this phone, battery and charger in too high or too low temperature zone, which may cause the product, battery and charger failure, fire or explosion.
  - When charging, the battery should be maintained at an ambient temperature between 0 °C and 40 °C. The temperature of battery storage environment should be maintained between -20 °C and 60 °C. If the battery is in hot or cold areas, the battery capacity and life may be reduced. When the temperature is below 0 °C, battery performance is particularly limited.
  - When the phone is close to ears, do not turn it on or off, that is bad to your health.
  - To comply with the provisions of RF leakage, when you wear the phone or use its data function, please keep its antenna away from your body at least 1 inch (2.5cm).
  - The phone's signal interference may influence the adjacent TV, radio or computer.
  - Please comply with RF radiation international norms, please use the designated product accessories.
  - When using this phone, please comply with the relevant laws and regulations, and respect others' privacy and legal rights. Before cleaning and maintenance, please turn it off.
- If it is still connected to the charger, you should unplug the charger from the power outlet, and disconnect charger and phone to avoid electric shock, short-circuit of battery or charger.
- Do not disassemble the phone. Only authorized institutions are allowed to repair this product.

12

## Safety warning

- Please turn it off before the phone is close high-precision control electronic equipment, or it may cause electronic equipment failure.
- Equipments will be influenced by the phone include: audiphones, pacemakers, fire alarms, automatic doors and other automatic control equipments. Users who are using electronic medical auxiliary equipment should confirm whether the radio wave will influence it or not with service center of the equipment.
- Pacemaker manufacturers recommend that the distance between the phone and a pacemaker should be kept at least 15 cm to avoid potential interference. Please do not carry the phone in your breast pocket; Please use the different side ear with pacemaker to answer calls to minimize the potential interference.
- Please do not bring the phone into the operating room, intensive care unit (ICU) or coronary care unit (CCU).
- In medical facilities where using mobile phones is prohibitive, please follow their instructions and regulations.
- Please pay attention to tone, volume, vibrate settings of the phone, so as not to influence heart disease patients.
- In inflammable and explosive areas, do not remove, install or charge the battery, so as not to cause explosion or fire.

13



Official website

Beijing Dorland System Control Technology Co., Ltd.  
Add: Room1107, Tower B, Tsinghua Tongfang Technology Square,  
No.1 Wangzhuang Road, Haidian District, Beijing, P.R.China  
Sales Hotline: +86-10-62164681 / 62198496  
Service Hotline: +86-10-62985217  
Mobilephone: +8613910650041  
Website: www.dorland-tech.cn  
E-mail: tian@dorland.com.cn  
PostCode: 100083

14