

# **VC series 30-60kw**

**Floor-mounted DC EV charger**

**Product specification**



# Catalogue

1.overview.....	1
2.Safety instructions .....	2
3.Appearance and Composition.....	2
4.Detailed technical parameters.....	3-6
5.Operation instruction.....	7-8
6.Electrical installation .....	8-9
7.Check after installation.....	9-10
8.Power on .....	11-13
9.Routine maintenance table .....	14
10.Precautions for Use .....	15-16
11.The appendix.....	17-18



## 2.Safety instructions

- Charging operation shall follow the operation instructions provided by our company;
- Non-professionals are strictly prohibited to open the charging machine cabinet; Do not disassemble or assemble without permission;
- When stopping midway, manually click the button to stop and then pull out the charging gun;
- It is strictly forbidden to insert or remove the charging gun directly during the charging process, otherwise it will burn out the charging gun and even the charger;
- Any operation unrelated to charging is prohibited during the charging process, and other operations can be carried out only when the charging gun is disconnected from the car and the charger button is clicked to stop.
- Avoid fireworks (open fire) near the charger and pay attention to ventilation;
- The fuse must be replaced with the same type of product, not with copper, iron wire replacement;
- There is high voltage in the charger, and any fault should be repaired by professional personnel to avoid danger;
- The superior circuit breaker and distribution device of the charger shall be selected, installed and operated by professional electrician;
- In severe weather such as thunderstorms, you are advised to disconnect the power supply. If water accumulates in the charger, contact the personnel of the manufacturer to handle the water before continuing to use the charger.
- The unit weight of the charging gun cable is large, and the long cable is easy to drag force in the actual charging process, which is not conducive to releasing the twisting force, increasing the risk of cable distortion and bulge, and affecting the service life of the product. Therefore, do not pull or twist the charging cable. The cable of the charging gun must be smoothed and not twisted to force the charging gun holder during use.
- Do not shake the charging gun from side to side when inserting or removing the charging gun. Insert and remove the charging gun vertically.
- If any of the following conditions occur, please turn off the power in time and notify professional personnel for repair:

- Abnormal sound appears inside the charger;
- Odor or smoke from inside the charger;
- No display or response on the charger screen;
- The charger has an unrecoverable fault alarm;



Note: Before powering on and running, ensure that the equipment shell is effectively connected to the earth, otherwise there may be electric shock risk!

## 3.Appearance and Composition



#### 4.Detailed technical parameters

##### 30kw series

ITEM		VC30750S	VC30750H	VC301KS
INPUT	Voltage range	AC380V±20%		
	Working frequency	45-65HZ		
	The power factor	≥0.99		
	Input current	0-58A	0-48A	0-58A
	Input cable length	Non		
OUTPUT	Power	30KW		
	Auxiliary power supply	GB/T:12V/24V CCS1 CCS2 CHAdeMO:12V		
	Voltage range	200-750Vdc	200-750Vdc	200-1000Vdc
	Output current	0-100A	0-75A	0-100A
	Charger mode	Single plug Full power charge/Dual plugs AB equalization		
	Charger plug	S: Single plug/D: Dual plugs		
	Cable	Default 5 meters (optional)		
The work environment	Temperature range	-20~50℃; 25℃ (type)		
	Humidity range	5~90RH%; (non-condensation)		
	Operation altitude	<2000M		
	Operation environment	Indoor/outdoor		
Dimensions and protection	Machine size(mm)	690x240x1350mm (Excluding head, handle and casters)		
	Packing size(mm)	1025 x 625 x 1535mm		
	Packed weight	About 195KG		
	Environment protection	IP54		
Starting mode	Plug and play/Swipe start/Input password start/VIN code			
Protection function	Scram ; Input over/under voltage ; Output overvoltage ; Overtemperature ; Overcurrent ; Short circuit ; Leakage ; Lightning ; Battery reverse; Insulation monitoring ;			
Human-computer interaction	7 inch color touch screen			
Screen language	Default English, other languages can be customized			
Charging mode	Plug and play、OCPP 1.6			
Networking mode	4G/WIFI/Ethernet			
Installation mode	Floor-mounted			
Charger standard	GB/T: GB/T 18487 、 GB/T 20234、 GB/T 27930			
	CCS: EN61851、 EN62196、 ISO15118、 DIN70121			
	CHAdeMO: CHAdeMO			

### 40kw series

ITEM		VC40750S	VC40750H	VC401K
INPUT	Voltage range	AC380V±20%		
	Working frequency	45-65HZ		
	The power factor	≥0.99		
	Input current	0-64A		
	Input cable length	Non		
OUTPUT	Power	40KW		
	Auxiliary power supply	GB/T:12V/24V CCS1 CCS2 CHAdeMO:12V		
	Voltage range	200-750Vdc		200-1000Vdc
	Output current	0-133A	0-100A	0-120A
	Charger mode	Single plug Full power charge/Dual plugs AB equalization		
	Charger plug	Single plug/Dual plugs		
	Cable	Default 5 meters (optional)		
The work environment	Temperature range	-20~50℃; 25℃ (type)		
	Humidity range	5~90RH%; (non-condensation)		
	Operation altitude	<2000M		
	Operation environment	Indoor/outdoor		
Dimensions and protection	Machine size(mm)	690x240x1350mm (Excluding head, handle and casters)		
	Packing size(mm)	1025 x 625 x 1535mm		
	Packed weight	About 200KG		
	Environment protection	IP54		
Starting mode	Plug and play/Swipe start/Input password start/VIN code			
Protection function	Scram ; Input over/under voltage ; Output overvoltage ; Overtemperature ; Overcurrent ; Short circuit ; Leakage ; Lightning ; Battery reverse; Insulation monitoring ;			
Human-computer interaction	7 inch color touch screen			
Screen language	Default English, other languages can be customized			
Charging mode	Plug and play、OCPP 1.6			
Networking mode	4G/WIFI/Ethernet			
Installation mode	Floor-mounted			
Charger standard	GB/T: GB/T 18487 、GB/T 20234、GB/T 27930			
	CCS: EN61851、EN62196、ISO15118、DIN70121			
	CHAdeMO: CHAdeMO			

### 60kw series

ITEM		VC60750S	VC60750H	VC601K
INPUT	Voltage range	AC380V±20%		
	Working frequency	45-65HZ		
	The power factor	≥0.99		
	Input current	0-116A		
	Input cable length	Non		
OUTPUT	Power	60KW		
	Auxiliary power supply	GB/T:12V/24V CCS1 CCS2 CHAdeMO:12V		
	Voltage range	200-750Vdc	200-1000Vdc	
	Output current	0-200A		
	Charger mode	Single plug Full power charge/Dual plugs AB equalization		
	Charger plug	Single plug/Dual plugs		
	Cable	Default 5 meters (optional)		
The work environment	Temperature range	-20~50℃; 25℃ (type)		
	Humidity range	5~90RH%; (non-condensation)		
	Operation altitude	<2000M		
	Operation environment	Indoor/outdoor		
Dimensions and protection	Machine size(mm)	690x240x1350mm (Excluding head, handle and casters)		
	Packing size(mm)	1025 x 625 x 1535mm		
	Packed weight	About 210KG		
	Environment protection	IP54		
Starting mode	Plug and play/Swipe start/Input password start/VIN code			
Protection function	Scram ; Input over/under voltage ; Output overvoltage ; Overtemperature ; Overcurrent ; Short circuit ; Leakage ; Lightning ; Battery reverse; Insulation monitoring ;			
Human-computer interaction	7 inch color touch screen			
Screen language	Default English, other languages can be customized			
Charging mode	Plug and play、OCPP 1.6			
Networking mode	4G/WIFI/Ethernet			
Installation mode	Floor-mounted			
Charger standard	GB/T: GB/T 18487 、 GB/T 20234、 GB/T 27930			
	CCS: EN61851、 EN62196、 ISO15118、 DIN70121			
	CHAdeMO: CHAdeMO			

## Combination mode of different ports

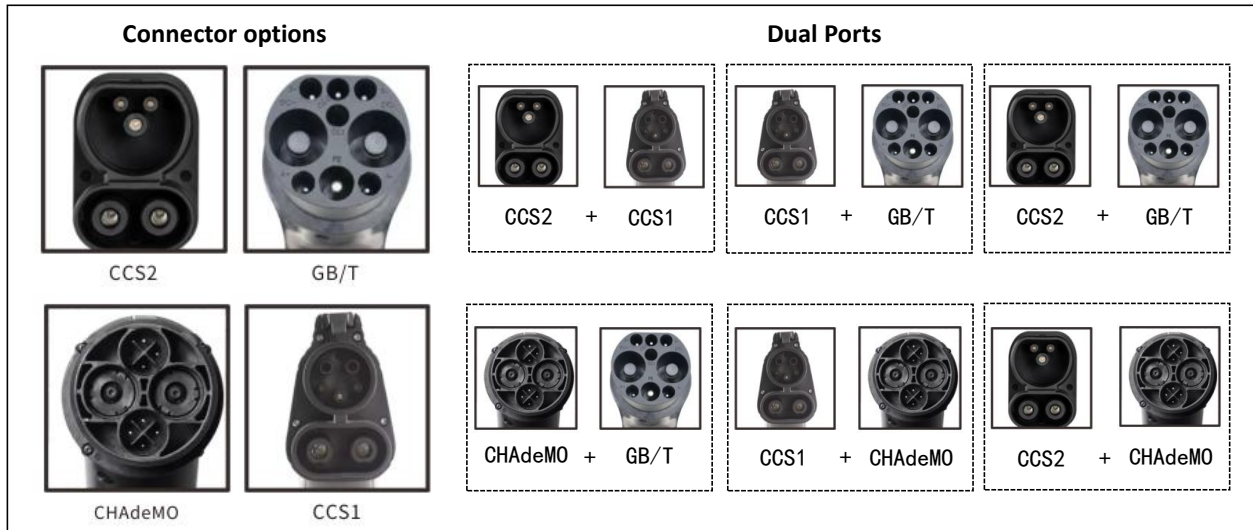

## 5. Operation instruction

### 5.1 Charging station installation

The charging equipment has high voltage and high current inside, in order to ensure personal safety, should always comply with the relevant regulations:

- (1) Only personnel who have received charging training and have full knowledge of DC charger can install this equipment. Safety precautions and local safety regulations should always be observed during installation;
- (2) Do not operate and maintain charger inside in thunderstorms or humid weather to prevent electric shock;
- (3) If operating inside the charger, ensure that the device is not charged;
- (4) The cabinet of the charger is equipped with a door lock, and the person in charge of the charger keeps key;

### 5.2 Installation preparation

#### (1) Unpack and check

When inspecting the goods, unpack and take out the packing list. Check the correctness and integrity of the equipment against the packing list and check whether the goods are damaged.

No.	Name	QTY	Remark
1	DC charger station	1	The contents listed in this packing list refer to the equipment and information included in the packing box
2	Inspection report (Certificate of conformity)	1	
3	Specification	1	
4	IC Card	2	
5	Key	1	

#### (2) Prepare cable

The selection of cables should comply with the relevant specifications of the electrical industry.

YJV type cables are recommended for input cables, and the cables should be at least  $>70^{\circ}\text{C}$  temperature resistant.



Determine the cable according to the following table.

Product mode	Input cable		
	Cable	Postion	Specification
30kw	AC three phases A	Plastic-case circuit breaker L1	$\geq 10\text{mm}^2$
	AC three phases B	Plastic-case circuit breaker L2	$\geq 10\text{mm}^2$
	AC three phases C	Plastic-case circuit breaker L3	$\geq 10\text{mm}^2$
	AC input N	Plastic-case circuit breaker N	$\geq 6\text{mm}^2$
	AC PE	Wire bar	$\geq 6\text{mm}^2$

Product mode	Input cable		
	Cable	Postion	Specification
40kw	AC three phases A	Plastic-case circuit breaker L1	$\geq 16\text{mm}^2$
	AC three phases B	Plastic-case circuit breaker L2	$\geq 16\text{mm}^2$
	AC three phases C	Plastic-case circuit breaker L3	$\geq 16\text{mm}^2$
	AC input N	Plastic-case circuit breaker N	$\geq 10\text{mm}^2$
	AC PE	Wire bar	$\geq 10\text{mm}^2$

Product mode	Input cable		
	Cable	Postion	Specification
60kw	AC three phases A	Plastic-case circuit breaker L1	$\geq 25\text{mm}^2$
	AC three phases B	Plastic-case circuit breaker L2	$\geq 25\text{mm}^2$
	AC three phases C	Plastic-case circuit breaker L3	$\geq 25\text{mm}^2$
	AC input N	Plastic-case circuit breaker N	$\geq 16\text{mm}^2$
	AC PE	Wire bar	$\geq 16\text{mm}^2$

### (3) Prepare tools

The following table lists the tools required for installing the charger. Before using the tools, take insulation and ESD preventive measures.

Tool list	
Adjustable wrench	Sleeve
Steel tape ruler	Screwdriver (Cross), (one word)
Electrician's knife	Spring washer, flat washer
Cable cutters	Hydraulic crimping pliers
Power cable strip	Digital multimeter
Percussion drill	Six M12*120 expansion screws

### (4) Cement base

Dimensions of the base are shown in the appendix

#### 5.3 Install the cabinet

(1) Cement base: Construction of cement base according to the size drawing of the base (see the attached drawing for details);

(2) When the cement base is constructed, it is necessary to consider that after the charging pile is installed, there is no obstacle on the front, the back is 100mm away from the obstacle, and the left and right sides are 1000mm away from the obstacle;

(3) Open the wooden case: remove the top cover and the surrounding sealing plate;

(4) Move the charger to the cement base with a forklift and adjust the position so that the fixing hole of the charger is aligned with the embedded stud of the cement base;

(5) Fine-tune the charging pile so that it stands upright in the middle of the cement base;

(6) Connect the cable at the bottom of the device.

## 6. Electrical installation

### 6.1 Connect grounding and input cables

-Open the cabinet door; Route the ground cable through the hole on the cabinet bottom, and secure one end of the cable to the ground copper bar.

-Connect the input cable and set all switches in the off position before electrical connection. Installation of input cables can only be performed by qualified personnel. **Do not reverse the input (N) and (PE); otherwise, the charging device will be damaged.**

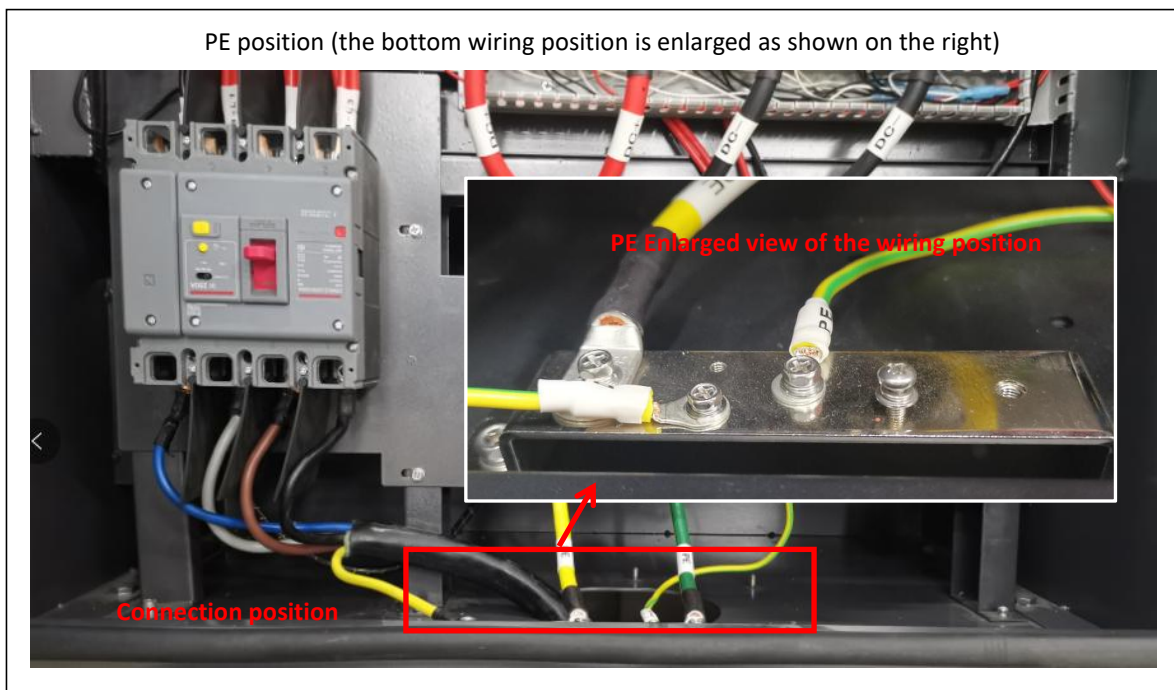

### L wire and N wire connection position

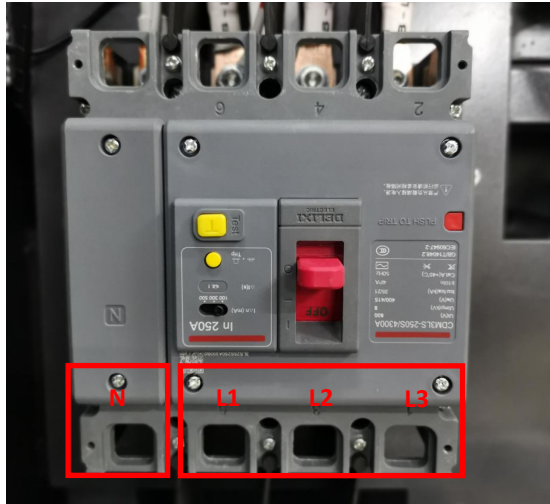

Please note that the three fire lines are not in phase sequence. However, the neutral line and the ground line must not be reversed, otherwise there will be the risk of burning the equipment!!

## 6.2 SIM card install

-Check the signal strength of mobile/telecom/Unicom operators at the installation site, select a suitable operator SIM card and insert it into the SIM slot

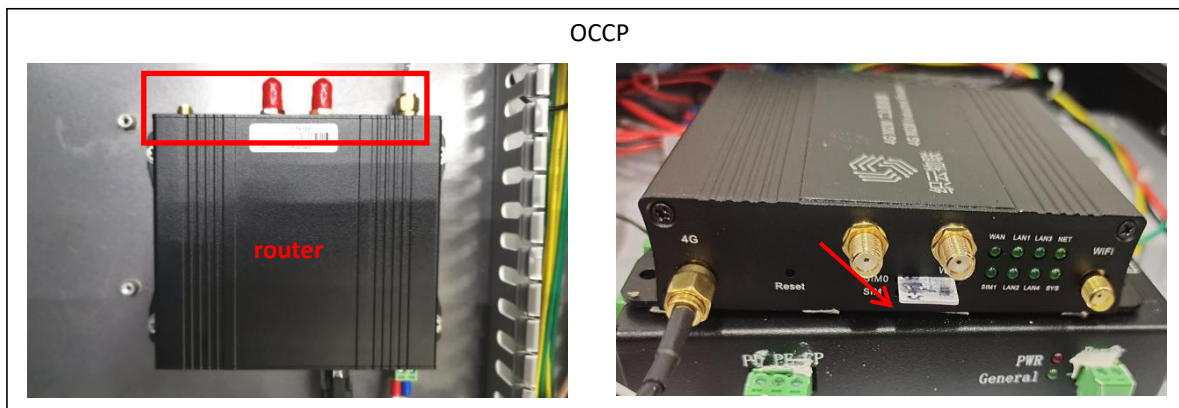

## 7. Check after installation

After the charger is installed, check the installation as follows:

### 7.1 External inspection

- Check whether the cabinet is installed horizontally, vertically, and securely.
- Check whether all bolts are tightened (especially pay attention to the electrical connection part), whether the flat washer and spring washer are complete, whether the installation is reversed, etc.;
- Check the equipment for unwanted materials and remove all excess materials;
- Check whether the cabinet is damaged or has lost paint. If the paint falls off, the part of the paint should be immediately repainted with anti-rust paint to prevent corrosion;
- Clean the cabinet;
- Check whether the opening and closing of the cabinet door are flexible, and whether the door lock is normal;
- Check whether the charging gun head can be easily inserted and removed;
- Check whether the air inlet filters at the lower sides of the cabinet are normal

## 7.2 Electrical inspection

- Check whether all circuit breakers and cable specifications of the charger are correct;
- Check that all cable connections are firm and reliable;
- Check AC input and power distribution: check whether the color of AC cables is standard, whether the original wiring of the device is tight, and whether the safety labels of the AC power distribution part are complete;
- Check whether the SPD circuit breaker is reliably closed and other switches are in the off position.
- Check whether the wiring is neat and the cable bundling complies with the process specifications.

## 8. Power on

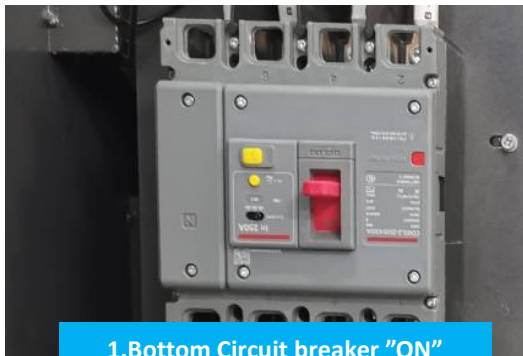

1. Bottom Circuit breaker "ON"



2. Intermediate air switch "ON"



3. plug

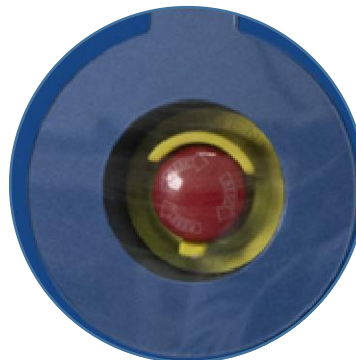

**In case of emergency or other uncontrollable failure, you can press the emergency button at the bottom of the charger screen to immediately shut down the device.**

### Plug and charge the charging procedure



1. Enter the welcome screen

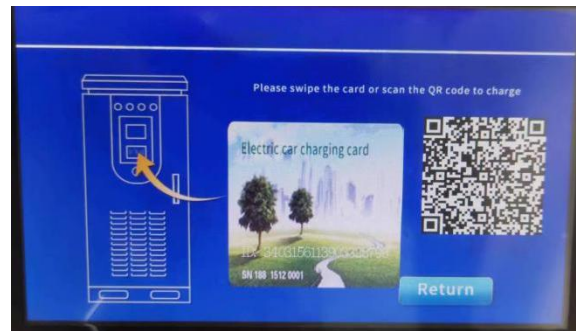

2. Prompt credit card



3. Swipe your IC card to enter



4. Automatic pre-charge check



5. Charging

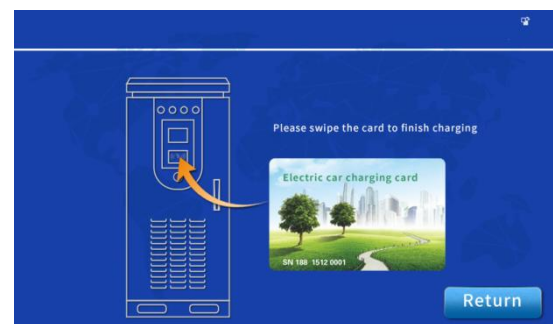

6. Swipe card finish charging

### 9. Routine maintenance table

Check the content	Check the method	Maintenance cycle
General operating status and environment of the system	<ol style="list-style-type: none"> <li>1. Observe whether the components, circuit and device structure of the charger are damaged or deformed;</li> <li>2. Listen to whether there is any abnormal sound when the charger is running;</li> <li>3. Check whether the data display on the touch screen is normal.</li> <li>4. Check whether the switch, contactor, circuit breaker, and fan are normal.</li> <li>5. Check whether the heat of the charger shell is normal;</li> <li>6. Observe whether the inlet and outlet air is normal;</li> <li>7. Check the humidity and dust around the charger.</li> </ol> <p>Attention! Intake ventilation must be checked. If the module is not cooled effectively, it will fail due to overheating.</p>	Once every six months

System clean	1. Check the cleanliness of circuit boards and components; 2. Check the temperature and dust of the internal charging module. Remove the module and clean it if necessary.	Once every six months to once a year (depending on the dust content of the environment)
Power circuit connection	1. Check whether the power cable and control cable are damaged, especially whether the skin in contact with the metal surface is cut; 2. Check whether the insulation bandage of the power cable wiring terminal is off.	Six months after the first commissioning, and then once every six months to a year
Cooling fan maintenance and replacement	1. Check whether there are cracks in fan blades; 2. Listen to whether there is abnormal vibration sound when the fan is running; 3. Replace the fan in time if it is abnormal.	Once a year
Circuit breaker maintenance	1. Check the corrosion of all metal components regularly (every six months); 2. Annual inspection of contactor to ensure good mechanical operation.	Once every six months to a year
Safety features	1. Check the function of emergency stop button and stop button; 2. Simulated shutdown.	Once every six months to a year

## 10.Precautions for Use

- (1) In the normal charging process, it is strictly forbidden to plug or remove the charging gun with electricity;
- (2) To end charging, you must first press the "Start/Stop" button, pull the gun, and then disconnect the charger to disconnect the mains;
- (3) Do not pull the locked gun out of the socket by brute force to avoid conductive materials such as metal foreign bodies entering the device.
- (4) Non-professionals do not open the charger shell to avoid damage to the charger;
- (5) Pay attention to the BMS power supply voltage of 12V or 24V, and select the corresponding charging model number.
- (6) The charger is equipped with a standard input cable. Users need to connect an external circuit breaker to ensure that the input PE cable is reliably grounded.
- (7) Only when the input power distribution capacity is not less than the rated power of the charger, can the charger be charged at full power.
- (8) Dc charging gun is standard, no need to install it separately;
- (9) Indoor drying is forbidden to be used in rainwater environment;
- (10) If there is a heat source near the charger, please move it as far as possible and take the surrounding space into full consideration to facilitate heat dissipation;
- (11) Avoid steam, dust and metal dust;
- (12) Keep away from flammable, explosive and corrosive gases and liquids;
- (13) Stay away from electromagnetic interference sources.

## 11.The appendix

### 11.1Quality assurance

During the warranty period, the company will repair or replace new products free of charge. During the warranty period, the company requires customers to show the invoice and date of purchase. At the same time, the trademark on the product should be clearly visible, otherwise the right not to give quality assurance. The unqualified products after replacement shall be handled by

our company. Customer shall allow company reasonable time to repair faulty equipment.

The company reserves the right not to guarantee quality in the following cases:

- The whole machine and parts have exceeded the free warranty period
- Transportation damage
- Incorrect installation, modification, or use
- Outdoor charging in rainy days leads to water inflow damage of charging pile.
- Extremely harsh operating conditions beyond those specified in this manual
- Machine failure or damage not caused by installation, repair, alteration or disassembly by our service personnel
- Failure or damage of the machine caused by non-standard use or not confirmed by the company
- Any beyond the scope of use specified in the relevant national standards
- Damage caused by abnormal natural conditions



Non-company personnel are prohibited to open the charging equipment, such as personal accidents, property accidents, safety accidents caused by this has nothing to do with the company.

In case of product failure caused by the above situation, if the customer requires maintenance service, the company can provide paid maintenance service after the judgment of the service organization.

#### 11.2 Precautions

The company does not assume any responsibility for the loss caused by the configuration software products provided with the products.

Any use of any or all of the data in the firmware or software developed by the company for commercial purposes is prohibited.

It is forbidden to decompile, decrypt or destroy the original program design of the software developed by the company.

## Charging station base installation diagram

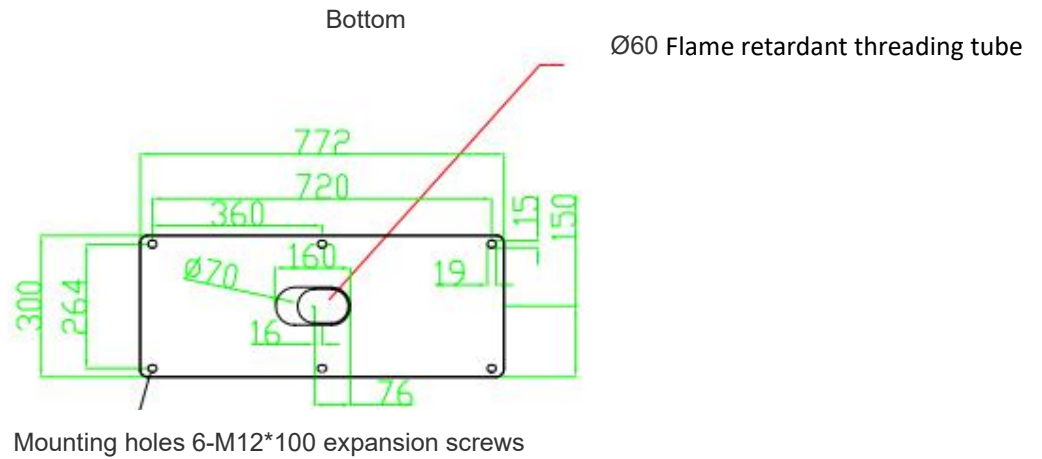

PVC flame retardant threading pipe,  
elbow higher than the top of the base  
100mm

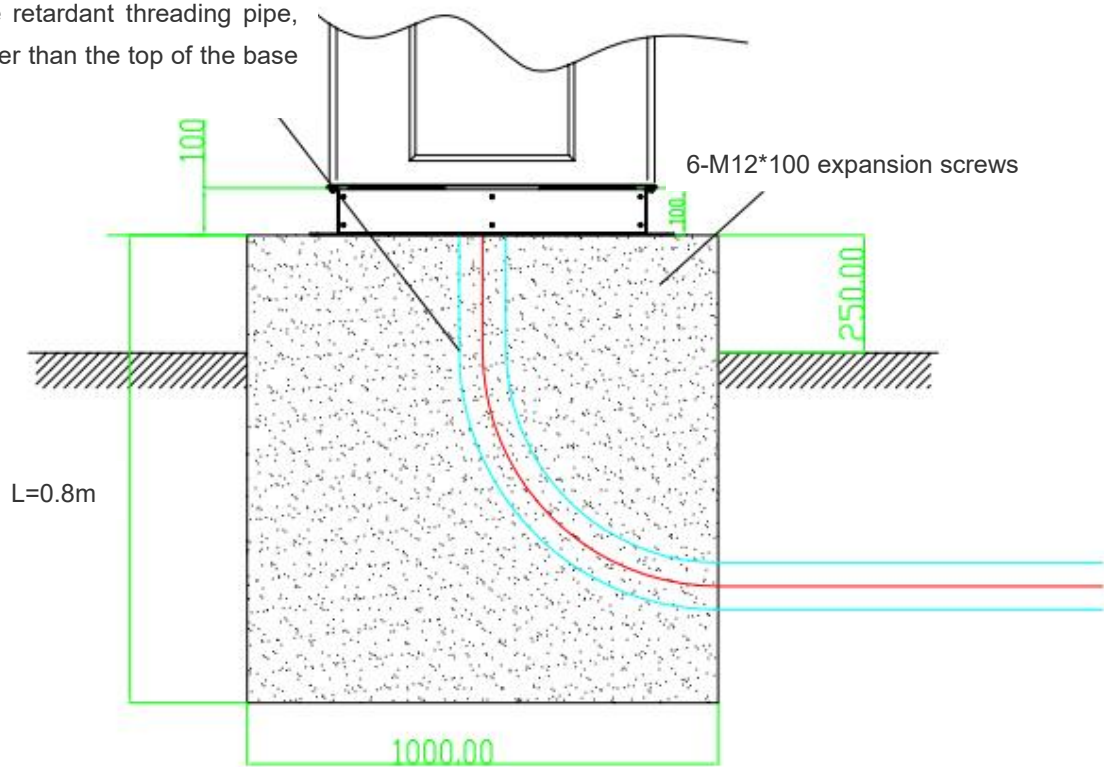



Outer diameter dimensions drawing(mm)

